

Hänvisningssystem



COSIGN

INTERIÖRT

FLEXIBLE

I-SIGN FLEX	06
I-SIGN FIX	08
FLAG	10
I-SIGN DISPLAY / DISPLAY SLIM	12
STRATO	16
CURVO PLUS	20

MODULAR

MODULE PLUS INDOOR	24
--------------------	----

LED SIGNS

LIGHTBOX	32
HIGHLIGHT	34
SOLED	36
LED LIGHT SHEETS	38

TEXTILE FRAMES

SINGLE & DOUBLE SIDED	40
-----------------------	----

TENSION

TENSION PROFILES	46
------------------	----

FIXINGS & SUSPENSION

INOX & ALUMINIUM FIXINGS	48
SUSPENSION KITS	52

EXTERIÖRT

MODULAR

MODULE PLUS OUTDOOR	56
---------------------	----

TOTEMS

TOTEM PYLONS	60
--------------	----

ALLTID HÖG KVALITET

ANPASSNINGSBART

INNOVATIVT

GENOMTÄNKT
LAGERHÅLLNING

ERFARENHET

FLEXIBELT

SERVICE

COSIGN

MODULAR SIGN SYSTEMS



DIN GLOBALA SKYLTPARTNER

Cosign etablerades redan 1993. Över de senaste 25 åren har Cosign blivit synonymt med arkitektonisk skyltning.

Det spelar ingen roll vilken typ av skyltar du behöver, skyltar för inomhusbruk eller utomhusbruk, flexibla eller modulära skyltar, skyltar med integrerad LED-teknik, annonsplattliknande skyltar, eller om så önskas skyltar med textilväv, Cosign är företaget du ska vända dig till.

Cosign är en global aktör med produktionsfaciliteter och distributionshubbar i Belgien (huvudkontor), Indien, Mexico, Brasilien och Hong Kong.

Vårt stora utbud av produkter är unikt. Tack vare vårt stora lager, kan vi styra upp snabba leveranser. Tjugo år av erfarenhet, välorganiserad logistik kring transporter, tillsammans med utmärkt service gör Cosign till en skyltleverantör och partner du kan lita på.

Cosign arbetar konstant med att utveckla innovativa lösningar till skyltindustrin tillsammans med toppdesigners som Stefan Schöning, Bart Bauwens (IDnA) och Fabrique.

DÖRRSKYLTA
INFORMATIONSSKYLTA
ALLMÄN SKYLTING
HÄNVISNINGSSKYLTA
UTRYMNINGSSPLANER
NAMNSKYLTA



I-SIGN

STRATO

FLEXIBLE



CURVO PLUS

I-FLAG

FLEXIBLA OCH MULTIFUNKTIONELLA

Våra flexibla skyltsystem erbjuder den perfekta lösningen i situationer där skyltbudskapet, eller i vissa fall hela skylten, måste kunna bytas ut på ett enkelt och smidigt sätt. Du skapar själv skyltbudskapet med dator och vanlig kontorsskrivare. Du kan alltså använda vanligt papper, men givetvis går det även bra med material som akryl, metall och PVC om du vill skapa något mer avancerat, som t.ex. en graverad eller taktill skylt.

De flexibla skyltarna finns i flera olika utföranden; väggmonterade skyltar, hängande skyltar, utstickande flaggskyltar och även bordsstående skyltar.

Skyltsystemen finns tillgängliga i standardformat hämtade från A-serien (t.ex A5, A4, A3 osv). Utöver standardformaten finns även aluminiumprofilerna och alla tillbehör, så som sidstycken och fästen, tillgängliga så att det går att kapa till och bygga en skylt efter egna mått. Dessutom, vid order av en större kvantitet, finns möjligheten att beställa specialtillverkade produkter.

I-SIGN FLEX

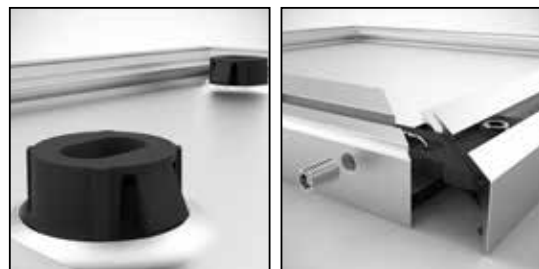
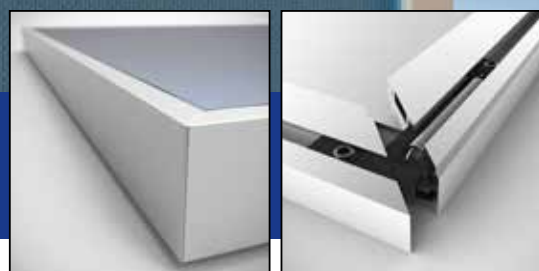

I-Sign Flex är en intelligent, modernt skyltsystem med flera karakteristiska drag:

1. Slimmad design. När skylten är ihopmonterad så ligger skyddsplasten i akryl på samma nivå som själva skyltramen i aluminium.
2. I-Sign Flex ramarna har en fjädrande konstruktion; Detta gör det extremt lätt att öppna och byta ut skyltbudskapet.
3. Flera alternativ vid väggmontering. Det går att använda dubbelhäftande tejp eller om man vill skruva upp skyltarna finns det "monteringsknappar" som är justerbara.
4. I-Sign Flex har en låsfunktion för att förebygga vandalism.
5. I-Sign skyltramen finns i både aluminium och ABS-plast.

STANDARDSTORLEKAR

VÄGGMONTERAD



product code	insert (hwx) in mm / instick (hxl) i mm
I-052148-W	52 x 148,5
I-060210-W	60 x 210
I-105107-W	105 x 107
I-105148-W	105 x 148,5 (DIN A6)
I-105148-WS	105 x 148,5 (DIN A6 slider)
I-148150-W	148,5 x 150,5
I-210148-W	210 x 148,5 (DIN A5)
I-210212-W	210 x 212
I-210297-W	210 x 297 (DIN A4 landscape)
I-297210-W	297 x 210 (DIN A4 portrait)
I-297299-W	297 x 299
I-420297-W	420 x 297 (DIN A3 portrait)
I-594420-W	594 x 420 (DIN A2)
I-841594-W	841 x 594 (DIN A1)

HÄNGANDE/NEDPENDLAD



product code	insert (hwx) in mm / instick (hxl) i mm
I-148297-S	148,5 x 297
I-148420-S	148,5 x 420
I-148600-S	148,5 x 600
I-148840-S	148,5 x 840
I-210297-S	210 x 297
I-210420-S	210 x 420
I-210600-S	210 x 600
I-210840-S	210 x 840

UTSTICKANDE (FLAGGSKYLTT)



product code	insert (hwx) in mm / instick (hxl) i mm
I-150148-P	150,5 x 148,5
I-212210-P	212 x 210
I-210297-P	210 x 297
I-297210-P	297 x 210

BORDSSTÅENDE



product code	insert (hwx) in mm / instick (hxl) i mm
I-052148-T	52 x 148,5

PROFILER & TILLBEHÖR

UTSTICKANDE PROFIL (PROFIL TILL FLAGGSKYLTT)



product code	description
FLAG2000	anodised / anodiserad 5m/l

FÄSTE TILL UTSTICKANDE FLAGGPROFIL



product code
I-BRACKET

VAKUUM SUGPROPP



product code
VACUUMC2

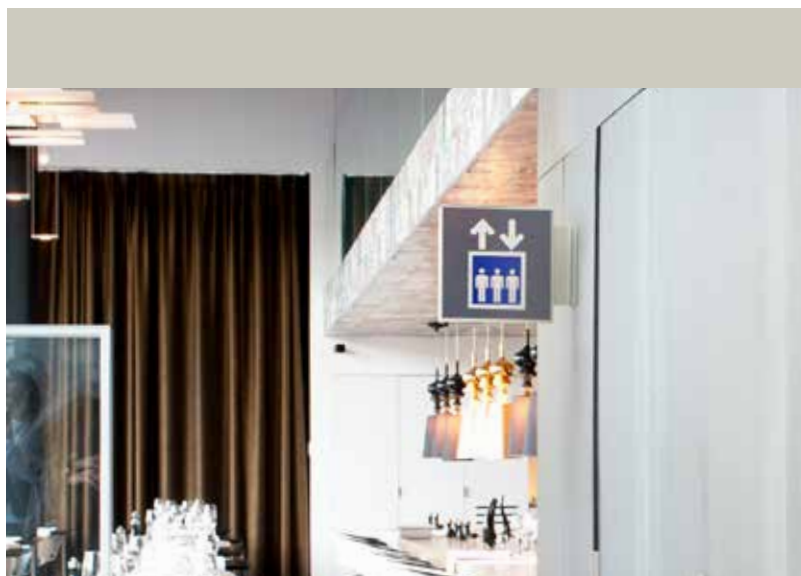

I-SIGN FIX



www.p3n.se

Precis som de andra skyltarna i I-Sign serien har I-Sign Fix samma slimmade designen. Notera hur den enkla, men samtidigt eleganta skyltramen har dolt infästning för skyltbudskap.

Skivmaterial med tjocklek 2-3mm kan monteras i ramen med små, innovativa clips (antingen med häftämne eller magnet). I-Sign Fix funkar alltså utmärkt till t.ex. taktila skyltar och skivmaterial i t.ex. PVC, ACM, akryl, aluminium och andra gravyrmaterial. Tack vare denna smarta lösning kan skyltramen fungera till många olika typer av skyltar.

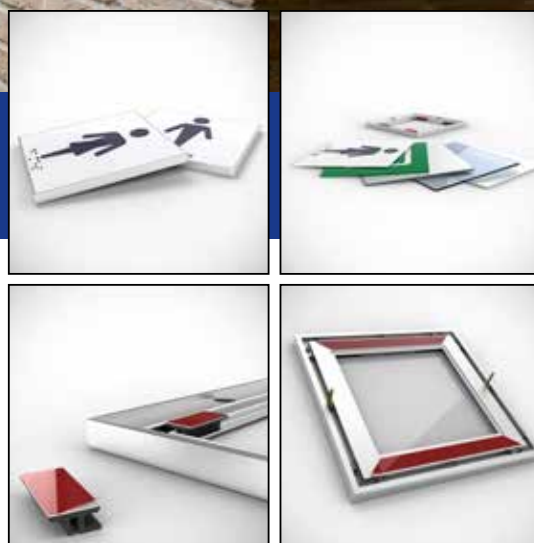

STANDARDSTORLEKAR

VÄGGMONTERAD



product code insert (hwx) in mm / instick (hxl) i mm

IF-150150-W	150 x 150
IF-150300-W	150 x 300
IF-150600-W	150 x 600
IF-297210-W	297 x 210 (DIN A4)
IF-297420-W	297 x 420 (DIN A3)

HÄNGANDE/NEDPENDLAD



product code insert (hwx) in mm / instick (hxl) i mm

IF-150150-S	150 x 150
IF-150300-S	150 x 300
IF-150600-S	150 x 600

UTSTICKANDE (FLAGGSKYLTT)



product code insert (hwx) in mm / instick (hxl) i mm

IF-150150-P	150 x 150
IF-150300-P	150 x 300
I-FLAG	150 x 161

VAKUUM SUGPROPP



product code

VACUUMC2

PROFILER & TILLBEHÖR

ALUMINIUMPROFILER



product code description

	wall mounted / väggmonterad	
IF-WM1000	mill finish / mill	5m/l
IF-WM2000	anodised / anodiserad	5m/l
IF-WM5000	black anodised / anod. svart	5m/l



	suspended / hängande	
IF-SP1000	mill finish / mill	5m/l
IF-SP2000	anodised / anodiserad	5m/l



	projected / utstickande	
FLAG2000	anodised / anodiserad	5m/l

FÄSTE TILL UTSTICKANDE FLAGGPROFIL



product code

I-BRACKET

HÖRNBIT



product code

IF-CORNER

MONTERINGSKLIPPS



product code

I-CLIP

CONNECTOR



product code

I-CONNECTOR

KLIPPS FÖR HÄNGANDE SKYLTT



product code

APC-3000S

VAJERKIT



product code description

APC4101	2x conical clip + 1,5m wire 2x klipp + 1,5m vajer
---------	--



I-FLAGG

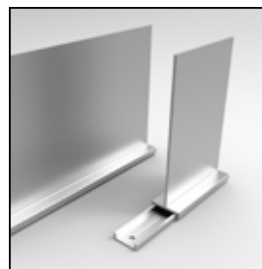

Cosign har utvecklat en universal flaggprofil som kan monteras på vägg eller i tak. Denna produkt kan användas både som den är, "stand-alone", så att säga, eller så kan man kombinera flaggprofilen med andra Cosign produkter, så som I-Sign Eco, I-Sign Flex eller I-Sign Fix.

Först monterar man ett aluminiumfäste i tak eller på vägg. Sedan trär man på själva flaggprofilen på aluminiumfästet och fixerar med skruvar.

STANDARDSTORLEKAR

I-FLAG 1

In combination with I-Sign Fix/Flex
I kombination med I-Sign Fix/Flex



product code

I-FLAG1

I-Flag 1 with mount 100mm
I-Flag 1 profil med höjd 100mm

I-FLAG 2



product code

I-FLAG2-150

I-Flag 2 with mount 150mm
I-Flag 2 profil med höjd 150mm

I-FLAG2-300

I-Flag 2 with mount 300mm
I-Flag 2profil med höjd 300mm

I-FLAG 3

In combination with I-Sign Eco
I kombination med I-Sign Eco



product code

I-FLAG3-100

I-Flag 3 with mount 100mm
I-Flag 3 profil med höjd 100mm

I-FLAG3-150

I-Flag 3 with mount 150mm
I-Flag 3 profil med höjd 150mm

PROFILER & TILLEBHÖR

FLAG1-2000

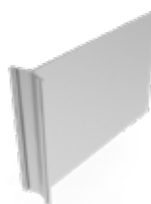

product code description

FLAG1-2000

anodised / anodiserad 5m/l

FLAG2-2000



product code description

FLAG2-2000

anodised / anodiserad 5m/l

MOUNT2-2000



MOUNT2-2000

anodised / anodiserad 5m/l

PROJECTING BRACKET FÄSTE TILL UTSTICKANDE FLAGGPROFIL



product code

I-BRACKET

Bracket for Flag1-2000
Fäste för Flag1-2000



I-SIGN DISPLAY



www.p3n.se

Den enkelsidiga I-Sign Displayprofilen gör det möjligt att rama in större skivor med t.ex. digital-printade motiv eller reproduktioner av konstverk, i princip helt utan synlig kant. Detta gör produkten ytterst lämplig för museum, gallerior och andra offentliga platser med behov av inredningsdekor eller konstnärliga utsmyckningar.

Den dubbelsidiga I-Sign Displayprofilen är lämplig till tunna ljuslådor och stora golvstående skyltar med eller utan inbyggd LED-belysning.

Det finns flera alternativ för hur man monterar skyltbudskapet I-Sign Display ramen, t.ex. dubbelsidig tejp, magnetisk tejp eller 3M's Dual Lock™ som är ett fästsystem för snabba upp- och nedmonteringar.



ENKELSIDIG

DUBBELSIDIG SLIMMAD

ALUMINIUMPROFILER



product code	description	
ID-SS1000	mill finish / mill	5m/l
ID-SS2000	anodised / anodiserad	5m/l
ID-SS5000	black anodised / anod. svart	5m/l

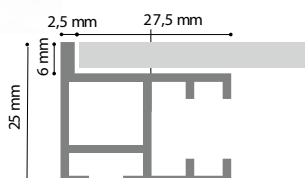

ALUMINIUMPROFILER



product code	description	
ID-SLIM1000	mill finish / mill	5m/l
ID-SLIM2000	anodised / anodiserad	5m/l

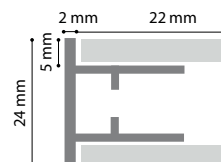

HÖRNFÄSTE



product code
ID-SS CORNER

LED LIGHT SHEET
(optional)

COSIGN MAGNET TAPE

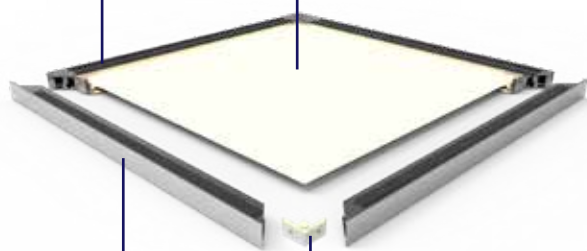

I-SIGN DISPLAY SS

CORNER CONNECTOR

HÖRNFÄSTE



product code
ID-SL CORNER

COSIGN MAGNET TAPE

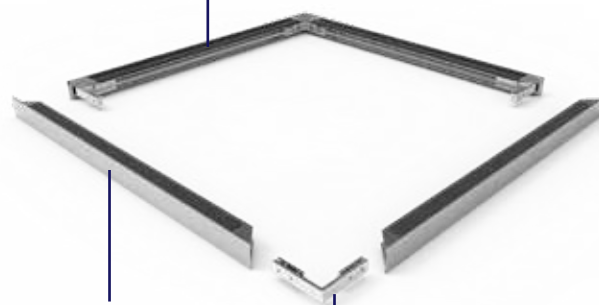

I-SIGN DISPLAY SLIM

CORNER CONNECTOR

MAGNETIC STRIPS / MAGNETREMSOR



product code	description	
MAG12.7/1.5A5	isotropic A, 5 poles	12,7 x 1,5 mm
MAG12.7/1.5B5	isotropic B, 5 poles	12,7 x 1,5 mm
MAG12.5.4/1.5A9	isotropic A, 9 poles	25,4 x 1,5 mm
MAG12.5.4/1.5B9	isotropic B, 9 poles	25,4 x 1,5 mm
MAG12.7/1.0A5	anisotropic A, 5 poles	12,7 x 1 mm
METAL13	metal strip	13 x 0,22 mm
METAL25	metal strip	25 x 0,22 mm

DUBBELSIDIG

ALUMINIUMPROFILER



product code	description		
ID-DS1000	mill finish / mill		5m/l
ID-DS2000	anodised / anodiserad		5m/l
ID-DS5000	black anodised / svart anod.		5m/l

HÖRNFÄSTE



product code

ID-DS CORNER

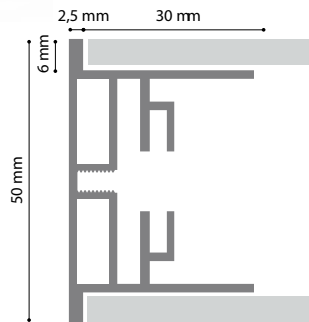

COSIGN MAGNET TAPE

LUCOLED EL31

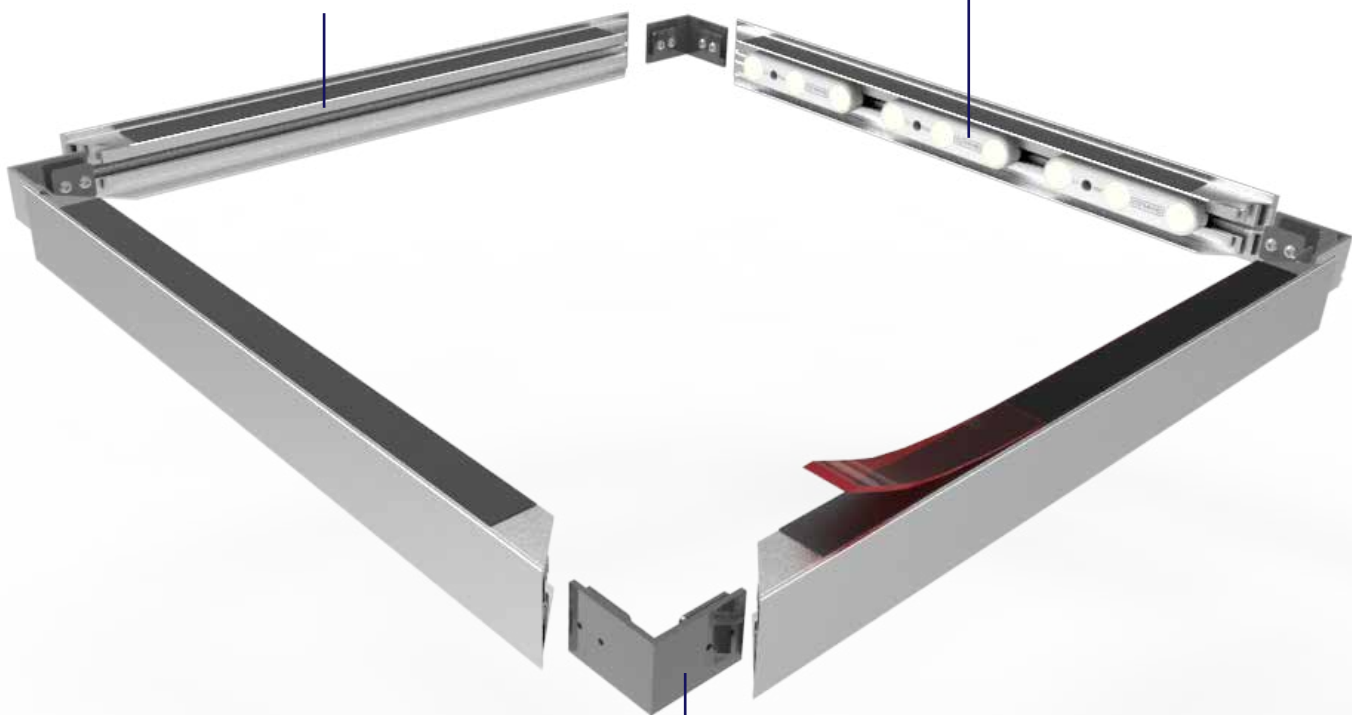

CORNER CONNECTOR



LUCOLED

Experience Lighting

LUCOLED EL31



product code	description	
EL31-W65	12 VDC	327lm / module
		2,88W / module

DRIVER



product code	description	
PPS1230	Lucoled Slim 12 VDC / 30W	
PPS1260	Lucoled Slim 12 VDC / 60W	
PPS12100	Lucoled Slim 12 VDC / 100W	
PP12150	Lucoled 12 VDC / 150W	
PP12200	Lucoled 12 VDC / 200W	

STRATO



www.p3n.se

STRATO är ett flexibelt och gångbart skyltsystem som består av en serie svagt utbuktande, konvexa, skyltprofiler.

Ett ark med papper kan skjutas in mellan skyltprofilen och frontplasten, som är tillverkad i icke reflekterande akryl. Det finns standardmått på skyltarna som är anpassade efter DIN formaten (A-serien, tex A5, A4 osv). Naturligtvis kan man istället för frontplast och pappersinstick använda andra plast-, eller metallmaterial som man skjuter in i skyltprofilen. En annan variant är att montera skyltbudskapet i form av skuren folie eller en printad dekal direkt på skyltprofilen.

Förutom skyltprofilen i aluminium och frontplasten så behövs sidostycken antingen i aluminium eller plast för att färdigställa skylten. Förutom de mest vanliga formaten finns det numera profiler och sidostycken så att man kan göra skyltar så breda som 400mm, 500mm och 600mm.



STANDARDSTORLEKAR

VÄGGMONTERADE



product code	insert (hwx) in mm / instick (hxl) i mm		
ST-056074-W	53	x 74 (DIN A8)	
ST-056105-W	53	x 105	
ST-056150-W	53	x 150	56mm
ST-056210-W	53	x 210	
ST-056297-W	53	x 297	
ST-078105-W	74	x 105 (DIN A7)	
ST-078150-W	74	x 150	
ST-078210-W	74	x 210	78mm
ST-078297-W	74	x 297	
ST-078420-W	74	x 420	
ST-109105-W	105	x 105	
ST-109150-W	105	x 150 (DIN A6)	
ST-109210-W	105	x 210	109mm
ST-109297-W	105	x 297	
ST-109420-W	105	x 420	
ST-150105-W	148	x 105 (DIN A6)	
ST-150150-W	148	x 150	
ST-150210-W	148	x 210 (DIN A5)	150mm
ST-150297-W	148	x 297	
ST-150420-W	148	x 420	
ST-212148-W	210	x 148 (DIN A5)	
ST-212210-W	210	x 210	212mm
ST-212297-W	210	x 297	
ST-212420-W	210	x 420	
ST-300210-W	297	x 210 (DIN A4)	
ST-300420-W	297	x 420 (DIN A3)	300mm
ST-300600-W	297	x 600	

UTSTICKANDE



product code	insert (hwx) in mm / instick (hxl) i mm		
ST-109148-P	105	x 148 (DIN A6)	109mm
ST-109210-P	105	x 210	
ST-150150-P	148	x 150	
ST-150210-P	148	x 210 (DIN A5)	150mm
ST-150297-P	148	x 297	
ST-212210-P	210	x 210	212mm
ST-212297-P	210	x 297 (DIN A4)	

BORDSSTÅENDE



product code	insert (hwx) in mm / instick (hxl) i mm		
ST-078105-T	74	x 105 (DIN A7)	78mm
ST-078150-T	74	x 150	
ST-109075-T	105	x 74	
ST-109148-T	105	x 148 (DIN A6)	109mm
ST-109210-T	105	x 210	
ST-109297-T	105	x 297	

HÄNGANDE



product code	insert (hwx) in mm / instick (hxl) i mm		
ST-109210-S	105	x 210	
ST-109297-S	105	x 297	109mm
ST-109420-S	105	x 420	
ST-109600-S	105	x 600	
ST-150297-S	148	x 297	
ST-150420-S	148	x 420	150mm
ST-150600-S	148	x 600	
ST-150840-S	148	x 840	
ST-212297-S	210	x 297	
ST-212420-S	210	x 420	212mm
ST-212600-S	210	x 600	
ST-212840-S	210	x 840	

HÄNGANDE I FLERA NIVÅER













product code	insert (hwx) in mm / instick (hxl) i mm		
ST-109210-SD	105	x 210	
ST-109297-SD	105	x 297	109mm
ST-109420-SD	105	x 420	
ST-109600-SD	105	x 600	
ST-150297-SD	148	x 297	
ST-150420-SD	148	x 420	150mm
ST-150600-SD	148	x 600	
ST-150840-SD	148	x 840	
ST-212297-SD	210	x 297	
ST-212420-SD	210	x 420	212mm
ST-212600-SD	210	x 600	
ST-212840-SD	210	x 840	
STRATOCON-2	Connectors / Connectors (2pcs)		
STRATOCON-4	Connectors / Connectors (4pcs)		

Example suspended system / Exempel på hängande skyltlar (ovan) 150 x 600mm, 2 levels/2 nivåer:
ST-150600-S + STRATOCON-2 + ST-150600-SD





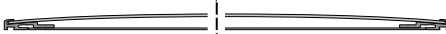











PROFER & TILLBEHÖR







ALUMINIUMPROFILER

	product code	profile	insert (hwx) / instick (lxh)	
	STRATO 2 0A8	56mm	DIN A8 (53mm)	5m/l
	STRATO 2 0A7	78mm	DIN A7 (74mm)	5m/l
	STRATO 2 0A6	109mm	DIN A6 (105mm)	5m/l
	STRATO 2 0A5	150mm	DIN A5 (148mm)	5m/l
	STRATO 2 0A4	212mm	DIN A4 (210mm)	5m/l
			DIN A3 (297mm)	5m/l
	STRATO 2 0A3S	edge profile / kantprofil		5m/l
	STRATO 2 0A3M	mid profile / mellanprofil		5m/l
		all sizes / alla storlekar		
	STRATOBS20	universal edge profile universell kantprofil		5m/l

ALUMINIUMSIDSTYCKEN

	product code	description
	STRALUCAPA8	A8 single-sided / enkelsidig
	STRALUCAPA8D	A8 double-sided / dubbelsidig
	STRALUCAPA7	A7 single-sided / enkelsidig
	STRALUCAPA7D	A7 double-sided / dubbelsidig
	STRALUCAPA6	A6 single-sided / enkelsidig
	STRALUCAPA6D	A6 double-sided / dubbelsidig
	STRALUCAPA5	A5 single-sided / enkelsidig
	STRALUCAPA5D	A5 double-sided / dubbelsidig
	STRALUCAPA4	A4 single-sided / enkelsidig
	STRALUCAPA4D	A4 double-sided / dubbelsidig
	STRALUCAPA3	A3 single-sided / enkelsidig
	STRALUCAPA3D	A3 double-sided / dubbelsidig
	STRALUCAP400	400mm single-sided / enkelsidig
	STRALUCAP500	500mm single-sided / enkelsidig
	STRALUCAP600	600mm single-sided / enkelsidig

SIDSTYCKEN I PLAST

	product code	description
	STRATOCAP3A8	A8, black / svart
	STRATOCAP3A7	A7, black / svart
	STRATOCAP3A6	A6, black / svart
	STRATOCAP3A5	A5, black / svart
	STRATOCAP3A4	A4, black / svart
	STRATOCAP3A3	A3, black / svart

2. grey/grå 3. black/svart

STANDARD REGISTERSKYLT



Directory example / Exempel (ovan) 400x600mm:
2x STRATO20A3S + 2x STRALUCAP400

VÄGGMONTERADE

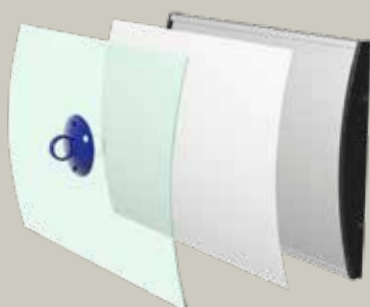

HÄNGANDE

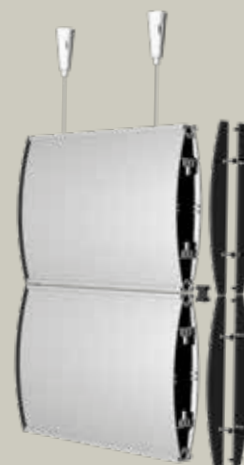

ACCESSORER

BORDSTÅENDE



product code	description
STRATOTS3A7	A7 black / svart
STRATOTS3A6	A6 black / svart
STRATOTS3UNI	universal black / universal svart

↳ 2. grey/grå 3. black/svart

VÄGGFÄSTEN FÖR UTSTICKANDE SKYLTT

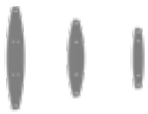

product code	description
STRATOBACRA6	A6 anodised / anodiserad
STRATOBACRA5	A5 anodised / anodiserad
STRATOBACRA4	A4 anodised / anodiserad

ANTI-REFLEX,SKYDDSPLAST



product code	description
STRATOSTRIPA8	1250 x 52,5 x 0,6mm
STRATOSTRIPA7	1250 x 74 x 0,6mm
STRATOSTRIPA6	1250 x 106 x 0,6mm
STRATOSTRIPA5	1250 x 147,5 x 0,6mm
STRATOSTRIPA4	1250 x 209,5 x 1mm
STRATOSTRIPA3	1250 x 297 x 1mm

SLIDERPROFIL I ALUMINIUM



product code	description
SLIDERRCS	slider profile. 2,5m sliderprofil 2,5m

SKRUV



product code	description
SCREW003	↳ 2. grey/grå 3. black/svart

KLIPPS, HÄNGANDE SKYLTTAR



product code	description
APC3000S	

CONNECTOR



product code	description
STRATOCON3	

VAJERKITT



product code	description
APC4101	2x conical clip + 1,5m wire 2x koniska takfästen + 1,5m vajer

UTSTICKANDE

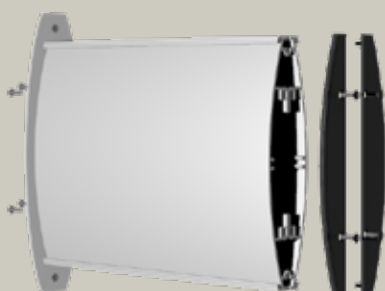

BORDSSTÅENDE



CURVO PLUS



www.p3n.se

Curvo Plus är ett modernt skyltsystem för inomhusbruk, tillverkat i högkvalitativ aluminium. Curvo skyltarna har en stilren, modern design med svagt konvex profil och runda hörn.

Skylten och frontplasten hålls ihop av fästen i rostfritt stål som bidrar till helhetsintrycket av skylten.

Fästena är dessutom samma till alla profilerna i skyltserien. Allt för att minska antalet komponenter och förenkla ihop monteringen av skyltarna.



STANDARDSTORLEKAR

VÄGGMONTERADE



product code	insert (wxh) in mm / instick (lxh) i mm		
CV-104150-W	89	x 150	104mm
CV-104210-W	89	x 210	
CV-104297-W	89	x 297	
CV-104420-W	89	x 420	
CV-134150-W	119	x 150	134mm
CV-134210-W	119	x 210	
CV-134297-W	119	x 297	
CV-134420-W	119	x 420	
CV-164105-W	149	x 105 (DIN A6)	164mm
CV-164150-W	149	x 150	
CV-164210-W	149	x 210 (DIN A5)	
CV-164297-W	149	x 297	
CV-164420-W	149	x 420	
CV-224150-W	210	x 150	224mm
CV-224297-W	210	x 297 (DIN A4)	
CV-312210-W	297	x 210 (DIN A4)	312mm
CV-312420-W	297	x 420 (DIN A3)	

UTSTÅENDE



product code	insert (wxh) in mm / instick (lxh) i mm		
CV-104090-P	89	x 90	104mm
CV-134120-P	119	x 120	134mm
CV-134240-P	119	x 240	
CV-164150-P	149	x 150	164mm
CV-164297-P	149	x 297	
CV-224210-P	210	x 210	224mm

HÄNGANDE



product code	insert (wxh) in mm / instick (lxh) i mm		
CV-104420-S	89	x 420	104mm
CV-104600-S	89	x 600	
CV-134420-S	119	x 420	134mm
CV-134600-S	119	x 600	
CV-164150-S	149	x 150	164mm
CV-164297-S	149	x 297	
CV-164600-S	149	x 600	
CV-164840-S	149	x 840	
CV-224297-S	210	x 297	224mm
CV-224600-S	210	x 600	
CV-224840-S	210	x 840	

BORDSSTÅENDE



product code	insert (wxh) / instick (lxh) i mm		
CV-164074-T	149	x 74	164mm
CV-164105-T	149	x 105 (DIN A6)	
CV-224074-T	210	x 74	224mm
CV-224105-T	210	x 105	

SUGPROPP



product code
VACUUMC2

VÄGGMONTERADE

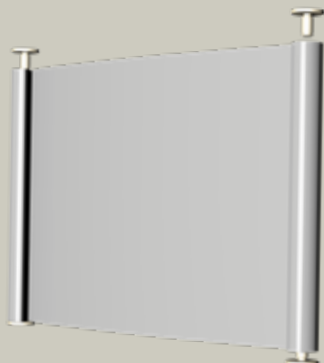







HÄNGANDE





PROFILER & TILLBEHÖR





ALUMINIUMPROFILER

	product code	profile	insert (wxh) / instick (lxh) i mm	
	CURVO 2 090	104mm	89mm	5m/l
	CURVO 2 120	134mm	119mm	5m/l
	CURVO 2 150	164mm	149mm	5m/l
	CURVO 2 210	224mm	210mm (DIN A4)	5m/l
	CURVO 2 297	312mm	297mm (DIN A3)	5m/l
				
	CURVO BS20	universal side profile universal sidoprofil		5m/l

FÄSTEN

	product code	description
	TAB001	inox-look / inox-look
	TAB002	baseplate / basplatta + 2x TAB002





ALUMINIUMSIDSTYCKEN

	product code	description
	CURCAP90	90mm double-sided / dubbelsidig
	CURCAP120	120mm double-sided / dubbelsidig
	CURCAP150	150mm double-sided / dubbelsidig
	CURCAP210	210mm double-sided / dubbelsidig

INOX, ROSTFRITT, STANDARD

	product code
	CURVOTS

FLAGGSKYLTSFÄSTEN

	product code	description
	CURBRAC90	support / support: 90mm
	CURBRAC120	support / support: 120mm
	CURBRAC150	support / support: 150mm
	CURBRAC210	support / support: 210mm

VAJER KITT

	product code	description
	APC4101	2x conical clip + 1,5m wire 2x koniskt takfäste + 1,5m vajer

ANTI-REFLEX,SKYDDSPLAST

	product code	description
	STRIP89	1250 x 89 x 0,6mm
	STRIP119	1250 x 119 x 0,6mm
	STRIP149	1250 x 149 x 1mm
	STRIP209	2050 x 209 x 2mm
	STRIP297	2050 x 297 x 2mm

UTSTICKANDE

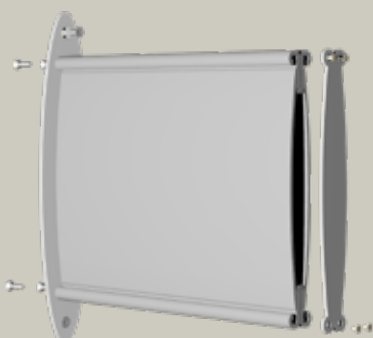

BORDSSTÅENDE



MODULE PLUS INOMHUS



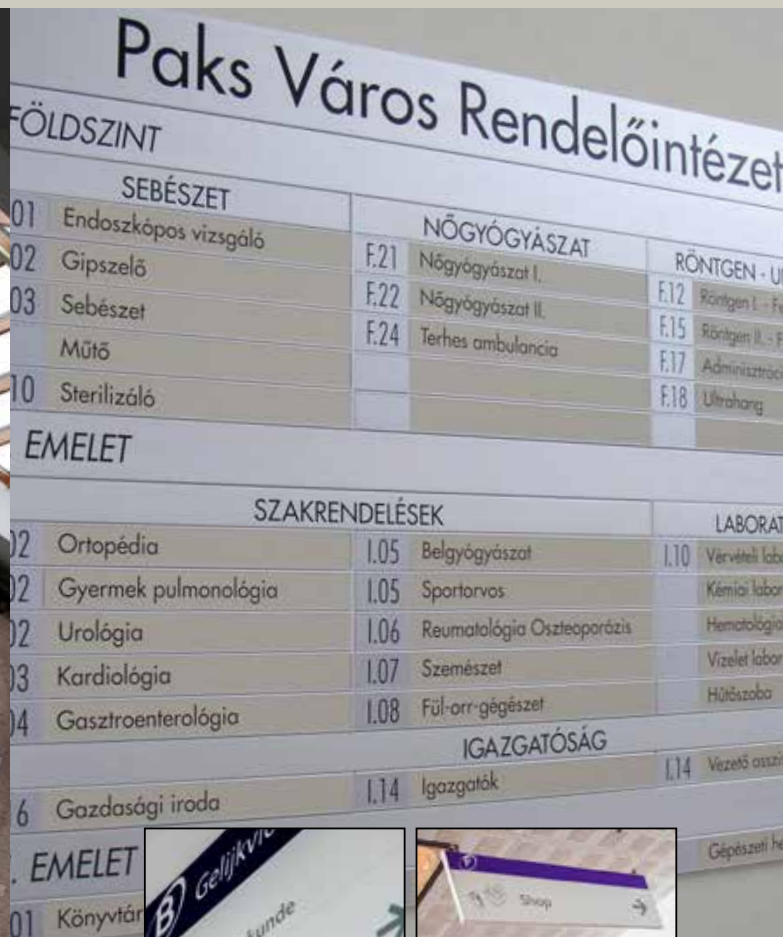

EN BEPRÖVAD KLASSISK PRODUKT SOM FORTSÄTTER ATT GÖR JOBBET UTMÄRKT!

Module Plus Indoor, kom på 1990 talet när Cosign bestämde sig för att ta fram ett modulärt skyltsystem. Module Plus har med tiden kommit att inspirera många andra kollegor i skylt branschen.

Module Plus Indoor består av en serie aluminiumprofiler som kan kapas i önskad längd. Aluminiumprofilerna, även kallade paneler eller lameller, finns i ett gäng standardhöjder, från 15,5 mm och uppåt. Dessa paneler kan klickas ihop med hjälp av sidostycken i plast eller aluminium och därigenom skapa t.ex. dörrskyltar, hänvisningsskyltar, orienteringstavlor m.m.

Förutom enkelsidiga skyltar för väggmontering, finns det även lösningar för dubbelsidiga hängande skyltar och flaggskyltar.

Module Plus Indoor systemet erbjuder inte bara en enkel, mångsidig lösning, utan möjliggör också för den kreativa skyltmakaren att sätta sin egen präglning på skyltarna och göra egna specialanpassningar.

PROFILER & TILLBEHÖR

TEXTPROFILER I ALUMINIUM

product code	profile
ANO 1 300	300 mm mill finish / mill 5m/l
ANO 1 250	250 mm mill finish / mill 5m/l
ANO 1 187	187 mm mill finish / mill 5m/l
ANO 1 156	156 mm mill finish / mill 5m/l
ANO 1 125	125 mm mill finish / mill 5m/l
ANO 1 093	93 mm mill finish / mill 5m/l
ANO 1 062	62 mm mill finish / mill 5m/l
ANO 1 046	46,5 mm mill finish / mill 5m/l
ANO 1 031	31 mm mill finish / mill 5m/l
ANO 1 015	15,5 mm mill finish / mill 5m/l

1. mill finish mill
2. silver anodised silver anodiserad
3. color färg
4. gold anodised guld anodiserad

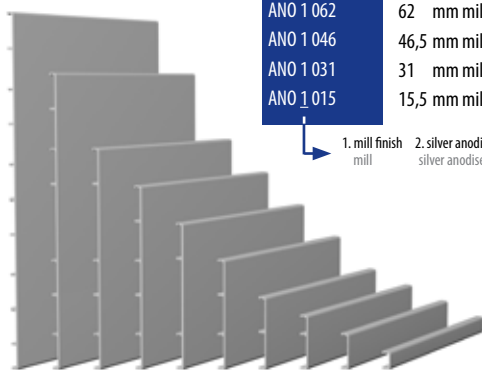

300 250 187 156 125 93 62 46,5 31 15,5 mm

SLIDERPROFIL I ALUMINIUM

product code	profile profil	insert instick	thickness tjocklek
ASO 1 093	93 mm	89,5 mm	≤1,6 mm
ASO 1 062	62 mm	58 mm	≤1,6 mm
ASO 1 046	46,5 mm	42,5 mm	≤1,2 mm
ASO 1 031	31 mm	27 mm	≤1,0 mm
ASO 1 015	15,5 mm	11,5 mm	≤1,0 mm



93 62 46,5 31 15,5 mm

ASO 1 031.SP	31 mm	custom	≤1,2 mm
--------------	-------	--------	---------

1. mill finish mill
2. silver anodised silver anodiserad
3. color färg
4. gold anodised guld anodiserad



ENKELSIDIGA SIDSTYCKEN

product code	description
APE 3 250	250 mm black / svart
APE 3 218	218 mm black / svart
APE 3 187	187 mm black / svart
APE 3 156	156 mm black / svart
APE 3 125	125 mm black / svart
APE 3 093	93 mm black / svart
APE 3 062	62 mm black / svart
APE 3 046	46,5 mm black / svart
APE 3 031	31 mm black / svart
APE 3 015	15,5 mm black / svart

1. white/blanc 2. grey/gris 3. black/noir

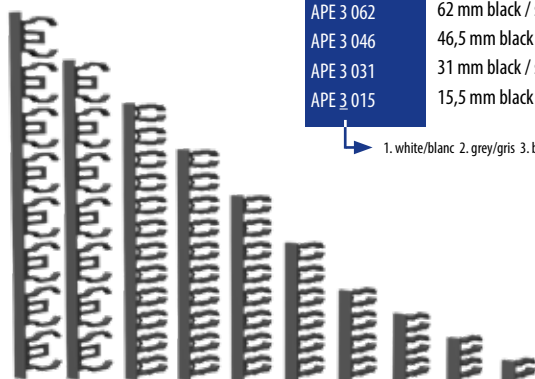

250 218 187 156 125 93 62 46,5 31 15,5 mm

DUBBELSIDIGA SIDSTYCKEN

product code	description
APD 3 300	300 mm black / svart
APD 3 250	250 mm black / svart
APD 3 187	187 mm black / svart
APD 3 156	156 mm black / svart
APD 3 125	125 mm black / svart
APD 3 093	93 mm black / svart
APD 3 062	62 mm black / svart

1. white/vit 2. grey/grå 3. black/svart

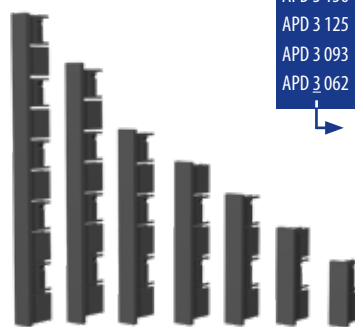

300 250 187 156 125 93 62 mm

VÄGGMONTERADE

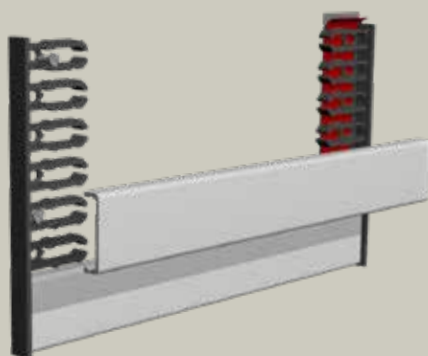

UTSTICKANDE

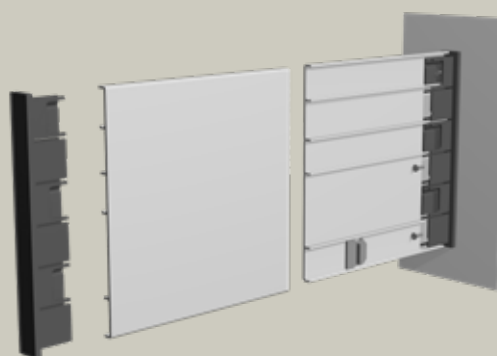

ACCESSOARER

VAJERKITT



product code	description
APC4101	2x conical clip + 1,5m wire 2x koniska takfästen + 1,5m vajer



product code	description
APC 3 000	plastic suspension clip / klip i plast för hängande skyltar 2. grey/grå 3. black/svart



product code	description
APC 4 400	metal suspension profile / profil i metall, för hängande skyltar
APC 4 500	metal suspension clip / metal clip för hängande skyltar (30mm)



product code	description
APC 6 000	wedge ABS black / kil i ABS-plast, svart

SUCTION CUP SUGPROPP



product code
VACUUMC2
VACUUMC

SKYLTVERKTYG



product code
APK1000

BORDSSTÄENDE



product code	description
APC7000	wedge / kil



product code	description
APW 3 031	triangular endcap / triangulärt sidstycke 1. white/blanc 2. grey/gris 3. black/svart

product code	description
APW 3 062	triangular endcap / triangulärt sidstycke 62mm 2. grey/gris 3. black/svart

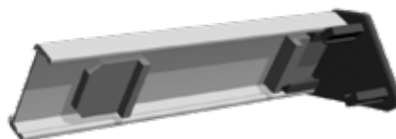

HÄNGANDE

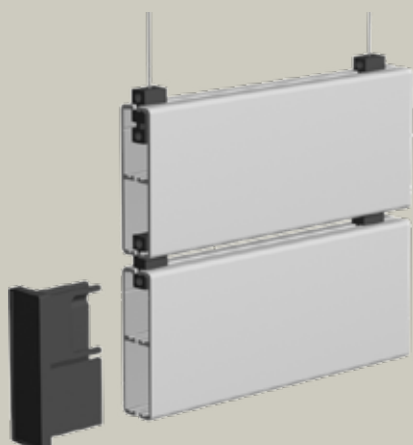

BORDSTÄENDE

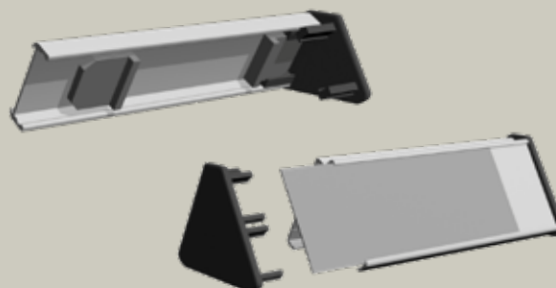

PROFILER

ALUMINIUMPROFILER



product code
AEO 1 000 description
straight / rak

1. mill finish mill 2. silver anodised anodiserad 3. color färg 4. gold anodised anodiserad



product code
AEO 1 000T description
triangular / vinklad

1. mill finish mill 2. silver anodised anodiserad 3. color färg 4. gold anodised guld anodiserad



product code
AEO 1 000R description
rounded / rundad

1. mill finish mill 2. silver anodised anodiserad 3. color färg 4. gold anodised anodiserad



product code
AEO 1 000.SP description
straight / rak

1. mill finish mill 2. silver anodised anodiserad 3. color färg 4. gold anodised guld anodiserad



product code
AEO 1 000R.SP description
rounded / arrondi

1. mill finish mill 2. silver anodised anodiserad 3. color färg 4. gold anodised guld anodiserad

TÖD- OCH AVDELANDEPROFILER



product code
ANS 1 000 omdescription
support profile / stödprofil

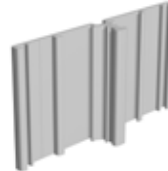

product code
AEO 1 001 divider profile / avdelande profil

1. mill finish mill 2. silver anodised anodiserad 3. color färg 4. gold anodised guld anodiserad

SIDPROFILER, KOMBINATIONER



product code
ARO 1 031 description
31mm brut, rounded / rundad 5m/l



ALO 1 015 15,5mm brut 5m/l
ALO 1 031 31mm brut 5m/l
ALO 1 046 46,5mm brut 5m/l
ALO 1 062 62mm brut 5m/l



ALO 1 031.S 31mm brut, single slider 5m/l
31mm, enkel sliderpanel

1. mill finish mill 2. silver anodised silver anodiseras 3. color färg 4. gold anodised guld anodiserad

RAMPROFIL



product code
AEO 1 000F 5m/l

1. mill finish mill 2. silver anodised silver anodiserad 3. color färg 4. gold anodised guld anodiserad

LAMELLSKYLTT

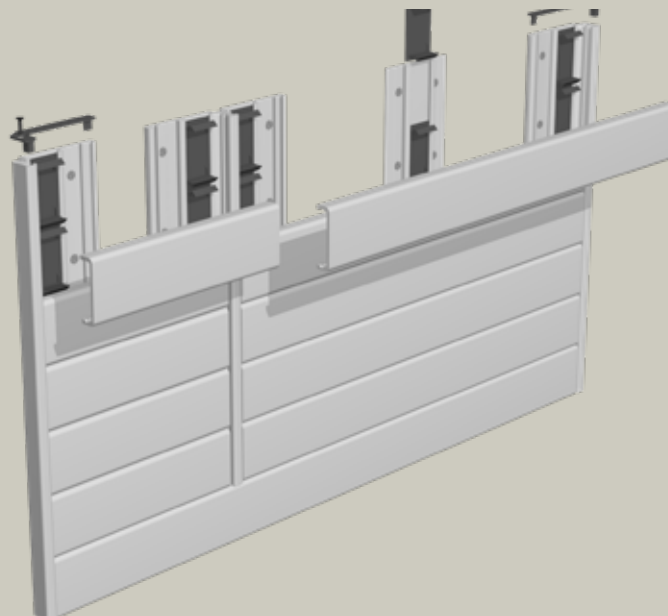

ACCESSOARER

TOPP- OCH BOTTEN LÅS FÖR SIDSTYCKEN



product code description
APT 3 000 straight / rak
 2. grey/grå 3. black/svart



product code description
APT 3 000B straight / rak
 2. grey/grå 3. black/svart



product code description
APT 3 000L rounded / rundad
 2. grey/grå 3. black/svart



product code description
APT 3 000T triangular / vinklad
 2. grey/grå 3. black/svart



product code description
APT 3 003R rounded / rundad
 2. grey/grå 3. black/svart



product code description
APT 3 006R for frame profile / för ramprofil
 2. grey/grå 3. black/svart

CLIPS FÖR SIDPROFILER



product code description
APC 5000 clips 31mm
APC 5001 clips 15,5mm



product code description
APC5000LS clips 6x31mm

TOTEM, INOMHUSBRUK



product code profile / profil
TOT 1 080.SP totem profile 5m/l
 totemprofil
 1. mill finish mill 2. silver anodised silver anodiserad 3. color färg



FLOORPLATE metal floorplate
 golvplatta i metall
 870mm x 200mm



TOPCOVER metal coverplate
 täckplatta i metall
 750mm x 80mm

TOTEMSKYLTT FÖR INOMHUSBRUK

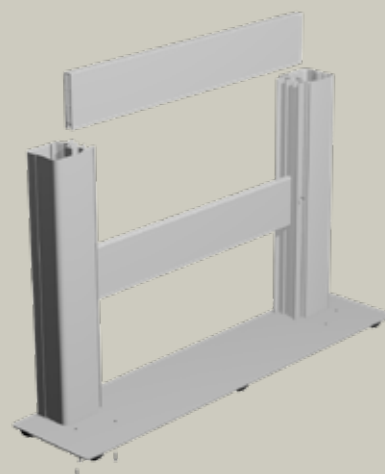
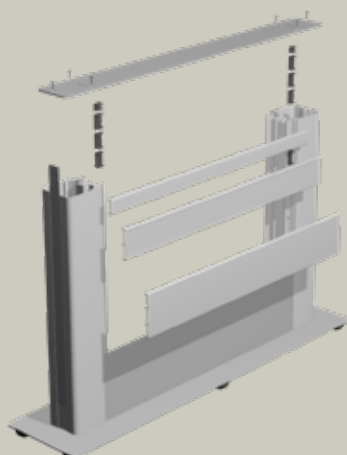



LJUSLÅDA

BELYSNINGSLIST

LED SKYLTAR



COSIGN FOTSÄTTER ATT FOKUSERA PÅ LED-SKYLTAR

LED-tekniken har ofantligt många fördelar jämfört med de gamla traditionella ljuskällorna. LED-dioderna blir inte lika varma, de är energisparande, säkra, hållbara, miljövänliga, underhållsfria och har en lång livslängd.

LED-tekniken fortsätter att utvecklas och förbättras kontinuerligt. Cosign håller givetvis ett öga på denna utveckling och har kommit med flera, nya, spännande LED-produkter, så som LED THINLITE, SOLED och PROFILED. Dessutom kan LED-moduler byggas in i I-SIGN DISPLAY-profilerna.

För att verkligen understryka sina ambitioner när det gäller LED-produkter har Cosign ingått ett partnerskap med amerikanska SloanLED. SloanLED är en trendsättare inom LED-teknologin och numera en av världens största tillverkare av högkvalitativa LED-moduler för skylt-branschen, efter att ha fattat en överenskommelse med brittiska Applelec gällande tillverkning och marknadsföring av LED Light Sheets.

LJUSLÅDA



Cosign har utvecklat en elegant inomhusljuslåda med ett djup på endast 75mm (enkelsidig) eller 100mm (dubbelsidig). Ramkonstruktionen är öppningsbar i toppen vilket gör att underhåll samt byte av skyltbudskap blir extremt smidigt.

Den öppningsbara ramen kommer i två versioner. En har den typiska I-Sign looken med en tunn, slimmad kant. Den andra har en kant som är 12,5mm vars konstruktion gör att akrylfronten blir upplyst hela vägen ut till kanten. Detta är den perfekta skyltlösningen till flygplatser, tunnelbanestationer, garage mm.



PROFILER & ACCESSOARER

ALUMINIUMPROFILER

product code	description	
LB-BASE-DS10	base profile double sided basprofil, dubbelsidig 1. mill finish mill 2. silver anodised silveranodiserad	6,1m/l
LB-BASE-SS10	base profile single sided basprofil, enkelsidig 1. mill finish mill 2. silver anodised silveranodiserad	6,1m/l
LB-FRAME-N10	frame profile 12,5mm silver anodised ramprofil, 12,5mm, silveranodiserad	6,1m/l
LB-FRAME-I10	frame profile 1,5mm silver anodised ramprofil, 1,5mm, silver anodiserad	6,1m/l
LB-HINGE	hinge profile mill finish gångjärnsprofil, mill finish	6,1m/l

ACCESSOARER

product code	description	
LB-BASE-CORNER	corner for base profiles hörn för basprofiler	6,1m/l
LB-FRAME-CORNER	corner for frame profiles hörn för ramprofiler	6,1m/l



ENKELSIDIG - RAM I

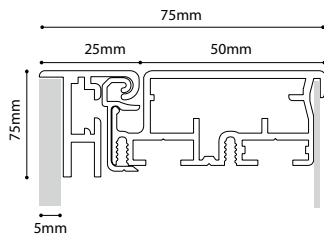

ENKELSIDIG - RAM N

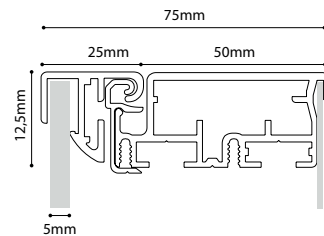

DUBBELSIDIG - RAM I

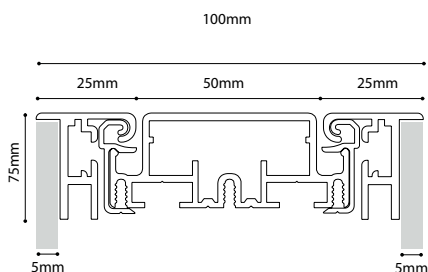

DUBBELSIDIG - RAM N

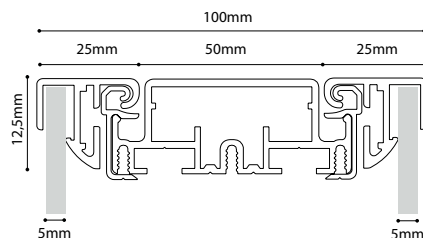

HIGHLIGHT

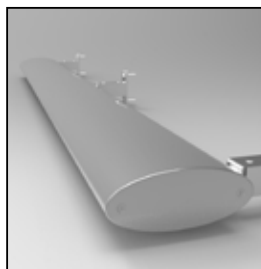

Highlight är Cosign's nya LED-belysta profil som, i kombination med SloanLed[®] HighLiner II moduler eller andra LED-moduler, är den perfekta lösningen när man vill ljussätta väggar på ett dekorativt sätt, eller lysa upp större ytor så som billboards, annonsplaceringar, fristående skyltar och stora pyloner.

Den elliptiskt formade aluminiumprofilen levereras inklusive följande delar;

- sidostrycken,
- LED-diffuserande täckskena i opal polykarbonat,
- lättn monterade väggfästen,
- distansprofiler,
- samt rörliga fästen så att få rätt vinkel på armaturen i förhållande till ytan man vill belysa.

PROFILER & ACCESSOARER

ALUMINIUMPROFILER



product code	description	
HL-PROF 1 000	highlightprofile highlightprofil	6,1m/l
	1. mill finish mill	2. silver anodised silveranodiserad

SIDSTYCKEN



product code	description
HL-CAP 1 000	endcap / sidostycke
	1. mill finish mill
	2. silver anodised silveranodiserad

VÄGGFÄSTE



product code	description
HL-WB 1 000	wall bracket / väggfäste
	1. mill finish mill
	2. silver anodised silveranodiserad

TÄCKPROFIL



product code	omschrijving	
HL-PC-OPAL	Polycarbonate cover profile	6,1m/l

DISTANSBITAR / MELLANBITAR



product code	description	
HL-SP 1 000	spacer 30x30x2mm	3m/l
	1. mill finish mill	2. silver anodised silveranodiserad

FÄSTE



product code	description
HL-HB 1 000	hinge bracket
	1. mill finish mill
	2. silver anodised silveranodiserad

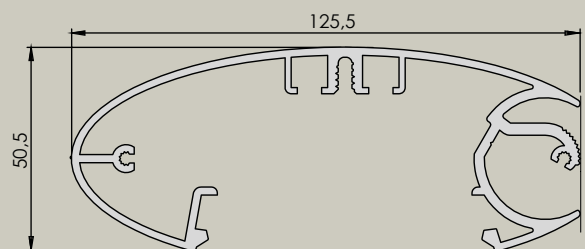
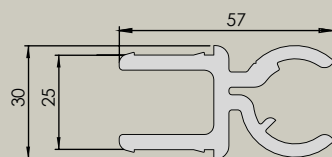
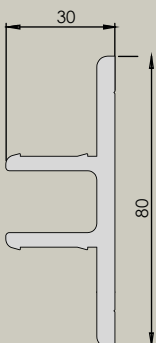

SOLED

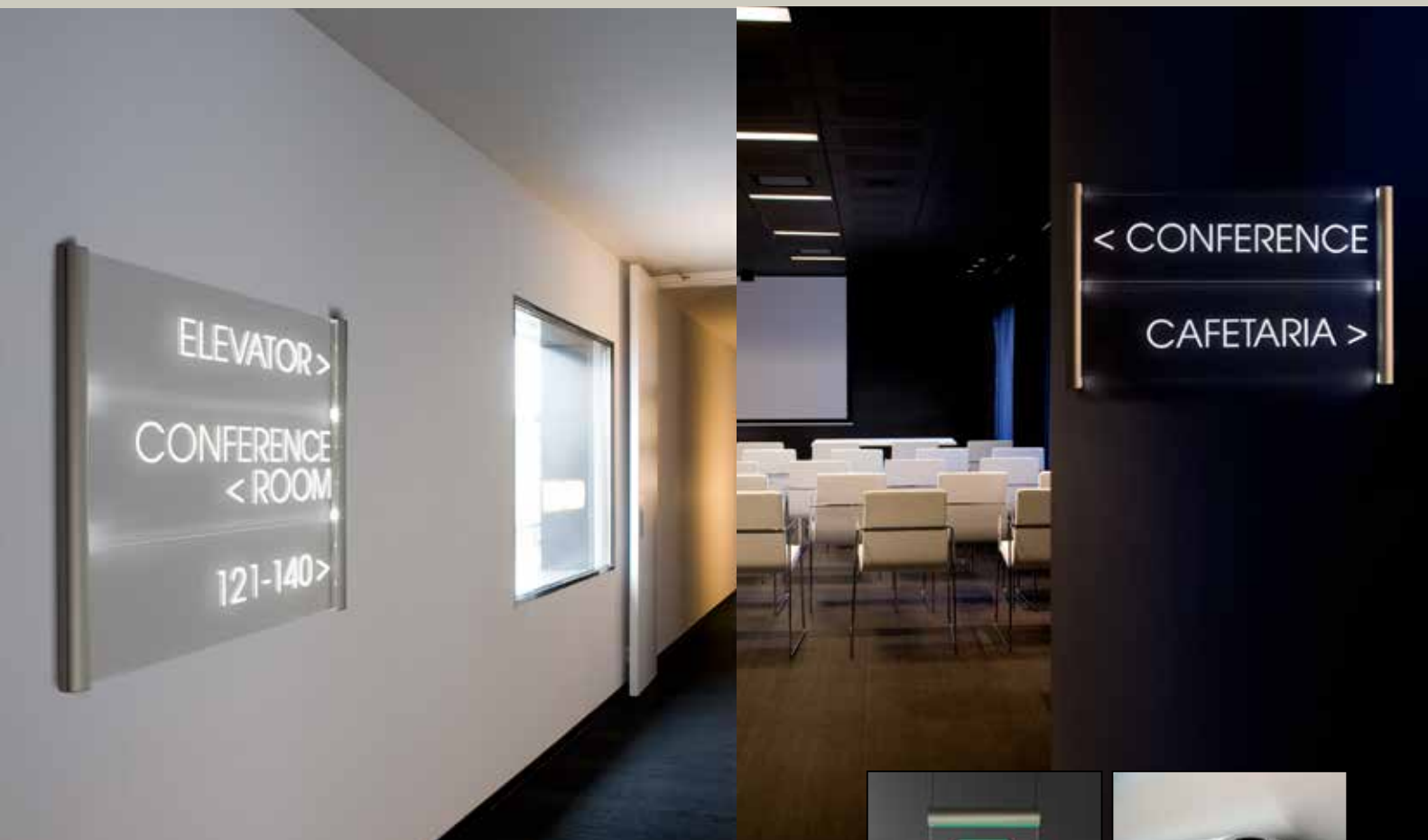

SOLED är ett skyltsystem med ett arkitektoniskt uttryck. En typisk SOLED skylt har en aluminiumprofil med integrerad LED, i form av en s.k. LED-strip, vars uppgift är att lysa upp en glas-, eller akrylskiva, från kanten. Med denna konstruktion kan man få en bild eller text på framsidan av den belysta skivan att lysa. Motivet man vill belysa kan lämpligtvis vara printad på transparent film eller gravras direkt in i skivan.

SOLED är ett modulärt system där kunden kan välja mellan rund, elliptiskt eller kvadratisk aluminiumprofil, samt om skylten ska vara väggmonterad, nedpendlad från tak eller utstickande från vägg.



PROFILER & ACCESSOARER

ALUMINIUMPROFILER



product code profile / profilé
SOL_1000.B base / basprofil 5m/l



SOL_1000.R round / rund 5m/l



SOL_1000.C ellipse / elliptisk 5m/l



SOL_1000.S square / rektangulär 5m/l
 1. mill finish minn 2. silver anodised silveranodiserad

ALUMINIUMSIDSTYCKEN



product code description
SOLCAP08.R round / rund (8mm)



SOLCAP12.R round / rund (12mm)



SOLCAP08.C ellipse / elliptisk (8mm)



SOLCAP12.C ellipse / elliptisk (12mm)



SOLCAP08.S square / kvadratisk (8mm)



SOLCAP12.S square / kvadratisk 12mm)



SOLCAP08.SC combined / kombinerad (8mm)



SOLCAP12.SC combined / kombinerad (12mm)

FÄSTE FÖR UTSTICKANDE SKYLTT



product code description
SOLBRAC08 for plates 8mm / Fäste för 8mm
SOLBRAC12 for plates 12mm / Fäste för 12mm

CLIP TILL VAJER



product code
APC3000S

VAJERKIT



product code description
APC4101 2x conical clip + 1,5m wire
 2x koniska takfästen + 1,5m vajer

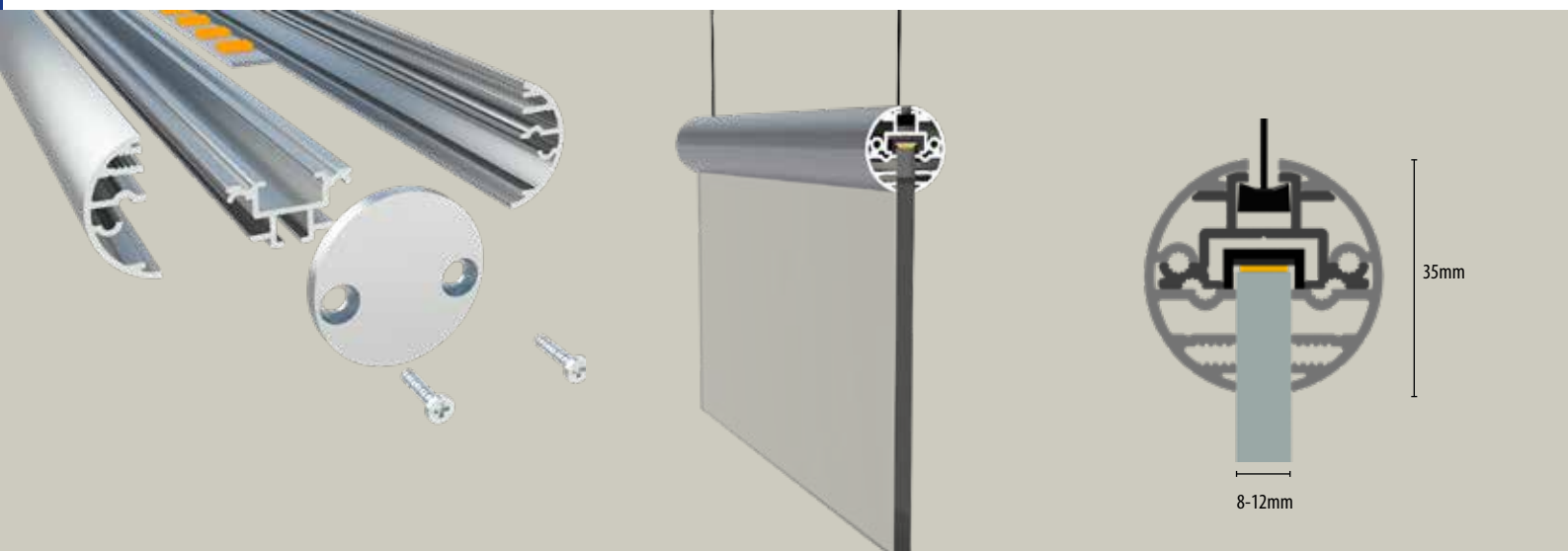

LED LIGHT SHEETS



LED Light Sheets är tunna akrylskivor med inbäddad LED. Produktens specifika uppbyggnad och sammansättning, tillsammans med det optiska mönster som graveras in i skivan, antingen med patenterad V-cut teknologi, eller med ett kundanpassat laserpunktmönster, gör att ljuset får en jämn fördelning över hela skivan.

LED Light Sheets kan levereras i alla storlekar och former, inklusive vit LED i olika färgtemperaturer, eller RGB LED om så önskas. LED Light Sheets är en inomhusprodukt och lämplig till display-, inrednings- och skyltprojekt där utrymmet för att få plats med belysning är begränsat.

TEKNISKA SPECIFIKATIONER

Material Material	Acrylic / Akryl (PMMA)
Thickness Tjockhet	6mm, 8mm, 10mm (RGB Leds / LED RGB)
Pattern Motiv/mönster	V-cut optical pattern / Optiskt mönster, V-cut (1,4mm - 2,8mm - 5,6mm) Laser dot pattern (personalised) Laserpunktmönster (personaliserad)
Max. size Maxdimensioner	3000mm x 1500mm
LED	5630 SMD LED (0,25W P=15mm)
Input voltage Spänning in	AC 100 - 240V 50/60Hz
Operating voltage Driftspänning	DC 12V - 24V
Efficiency Effektivitet	120lm / W
Colour temperature Färgtemperatur	3000K, 3700K, 4100K, 5300K, 6000K, 6500K, RGB
CRI Färgåtergivningsindex	65 - 90
Degree of protection Klassificering	IP54 - IP67
Service life Livsläng	>50.000 uur (L ₇₀)
Guarantee Garanti	LED Light Sheets (3 years / 3 år) - acrylic / Akryl (5 years / 5 år)
Operating temperature Driftstemperatur	-30°C tot +40°C -30°C tom +40°C
Accessories Accessoarer	Power supplies, connectors, splitters, RGB drivers, dimmers. Ettillbehör, connectors, splitters, RGB drivers, dimrar.



TEXTILRAMAR



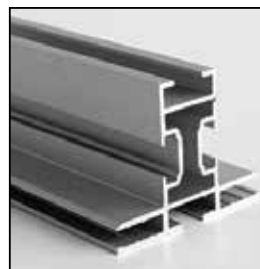

COSIGN TEXTILRAMAR: OÄNDLIGA MÖJLIGHETER







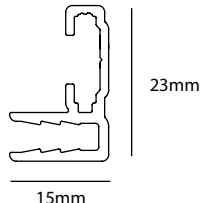

Cosign's textiliramar är lösningen för hur man snabbt och enkelt hanterar skyltning med, och byte av, printade textilier. Den printade textilväven förses med en silikonkant. Denna kant pressas sedan igenom aluminiumprofilen som ser till att väven blir perfekt spänd över hela ytan.

Textiliramarna är särskilt lämpade när man ska inreda och skylta upp butiker, showrum, kontor och mässmontrar. Detta tack vare smidigheten i att använda Cosign's aluminiumprofiler i kombination högkvalitativa textilvävar. Resultatet blir skarvlösa textilinstallationer som kan täcka stora ytor. Oavsett om du vill ha en vägghängd ram, en golvsstående ram, eller en ram nedpendlad från taket, så finns lösningen i Cosign's sortiment av enkel- och dubbelsidiga textil profiler.

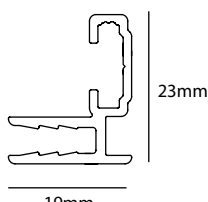
Cosign erbjuder också LED-profiler, där man kan integrera s.k. "High Power LED moduler" i textilramen som lyser upp hela duken och gör rättvisa åt motivet. Man kan även inkludera ljuddämpande material bakom den printade duken för att förbättra akustiken i rummet. Ett annat användnings-område för en ljuddämpande textiliram är om man vill skapa rumsavdelare. Förutom profiler och tillbehör kan Cosign även erbjuda kundanpassade lösningar inklusive print på duk och LED-bestyckning.

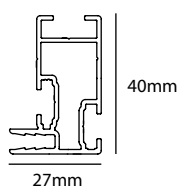
PROFILER

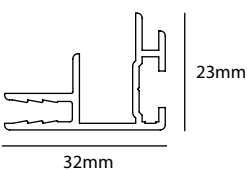
ENKELSIDIGA PROFILER FÖR TEXTILRAMAR

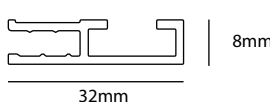



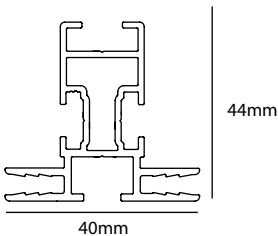
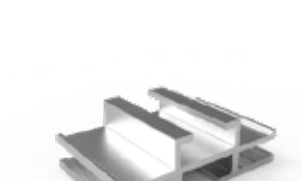
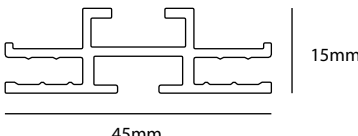





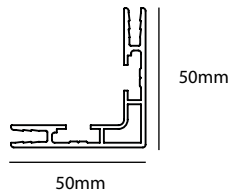
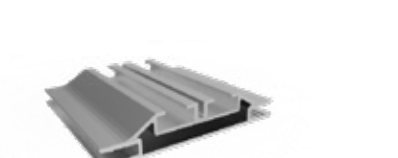

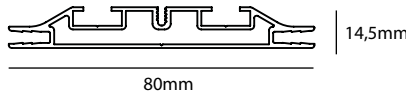

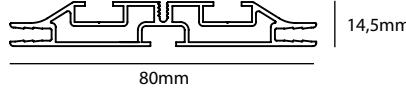

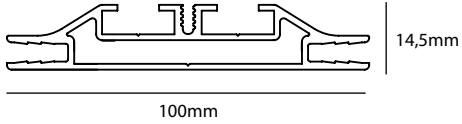
	product code	profile / profil			
	TEXSSLD15	15x23mm (light duty)	6,1mtr		
	TEXSSLD19	19x23mm (light duty)	6,1mtr		
	TEXSSHD27	27x40mm (heavy duty)	6,1mtr		
	TEXLLS32	32x23mm (Led Light Sheet)	6,1mtr		
	TEXNICHE	32x8mm (niche)	3mtr		

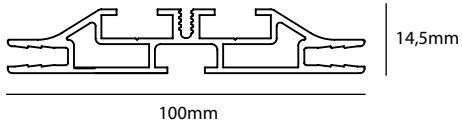
DUBBELSIDIG PROFIL FÖR TEXTILRAMAR

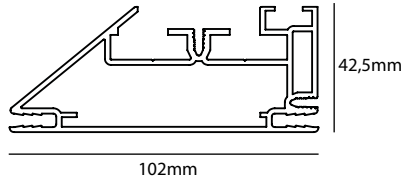
	product code	profile / profiler			
	TEXDSD44	44x40mm (heavy duty)	6,1mtr		
	TEXDSL45	45x15mm	3mtr		

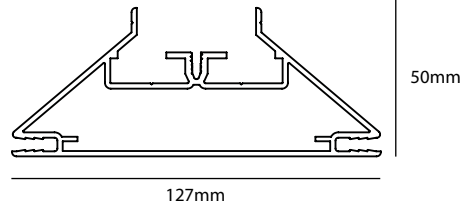
PROFILER

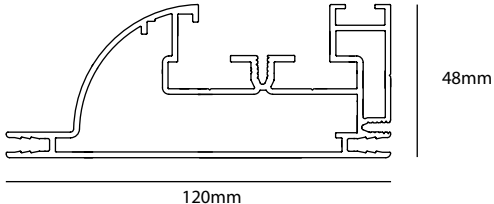
PROFILER FÖR TEXTILRAMAR MED LED

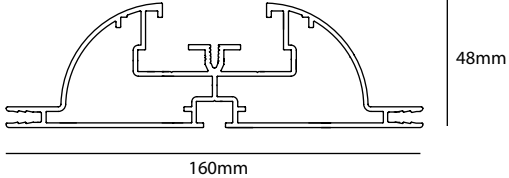
	product code	profile / profil	6,1mtr	
	TEXLED50	160x48mm	6,1mtr	50mm
	TEXLED80	80x14,5mm	6,1mtr	
	TEXLED80T	80x14,5mm	6,1mtr	
	TEXLED100	100x14,5mm	6,1mtr	
	TEXLED100T	100x14,5mm	6,1mtr	
	TEXLEDSS-BL	102x42,5mm	6,1mtr	
	TEXLEDSS-BL	127x50mm	6,1mtr	
	TEXLEDSS-EL	120x48mm	6,1mtr	
	TEXLEDSS-EL	160x48mm	6,1mtr	

PROFILER & ACCESSOARER

HÖRNCONNECTORS

	product code	description
	TEXCORNS	for profile / till profil TEXSSHD27, TEXNICHE, TEXDSDL45
	TEXCORNL	for profile / till profil TEXSSLD15, TEXSSLD19, TEXSSHD27, TEXDSDH44, TEXLLS32
	TEXCORN1	for profile / till profil TEXLEDSS(BL/EL), TEXLEDDS(BL/EL)
	TEXCORN2	for profile/ till profil TEXLED80, TEXLED80T TEXLED100, TEXLED100T TEXLED50
	CONNECTOR1	for profile/ till profil TEXSSLD15, TEXSSLD19, TEXSSHD27, TEXLLS32, TEXDSDH44, TEXNICHE
	CONNECTOR2	for profile/ till profil TEXSSHD27, TEXDSDH44, TEXLED50
	CONNECTOR3	for profile/ till profil TEXLEDSS (BL/EL), TEXLEDDS (BL/EL)
	CONNECTOR4	for profile/ till profil TEXLED80, TEXLED80T TEXLED100, TEXLED100T

CLIP FÖR HÄNGANDE MONTERING

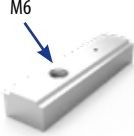
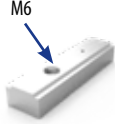
	product code	description
	TEXHANG1	metal suspension clip for 1.5mm cable/ metallclip för hängande montering TEXDSDH44, TEXLEDDS-EL
	TEXHANG2	metal suspension clip for M6 rod/threaded bar/ metallclip för hängande montering TEXLED80T / TEXLED100T

MONTERINGSFÄSTEN

	product code	description
	TEXBRACKET1	Wall mounting bracket for TEXLEDSS(BL/EL) , TEXSSHD27
	TEXBRACKET2	Wall mounting bracket for TEXLED80, TEXLED80T TEXLED100, TEXLED100T

H-PROFIL

	product code	profile / profil
	TEX-H	36x19mm 3mtr
	TEXCLAMP	for profile / till profil TEX-H
	TEXCORNH	connector for profile/ connector till profil TEXLEDSS (BL/EL) + TEX-H TEXLEDDS (BL/EL) + TEX-H

PROFILES & ACCESSORIES / PROFILER & ACCESSOARER

MOUNTING CLIP MONTERINGSCLIPS

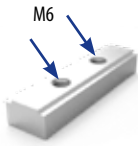

product code description
TEXMOUNT1 metal clip for M6 rod/threaded bar/
 metallclip till
 TEXDSD44 / TEXLEDDS-EL

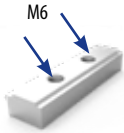

product code description
TEXMOUNT2 metal clip for M6 rod/threaded bar/
 metallclip till TEXLED80T /
 TEXLED100T

STANDING KIT KIT, STÅENDE



product code description
TEXFOOT40 foot / pied 400mm



product code description
TEXFOOT60 foot / fot 600mm



product code description
TEXFEETSIDE side support / sidostöd

FLOOR PLATES GOLVPLATTOR



TEXCIRCLE circle / cirkel \varnothing 450 x 6mm



TEXHOOP hoop / ring \varnothing 450 x 6mm



TEXBASE baseball / baseboll 450 x 300 x 6mm



TEXFILLET fillet / organisk 500 x 180 x 6mm

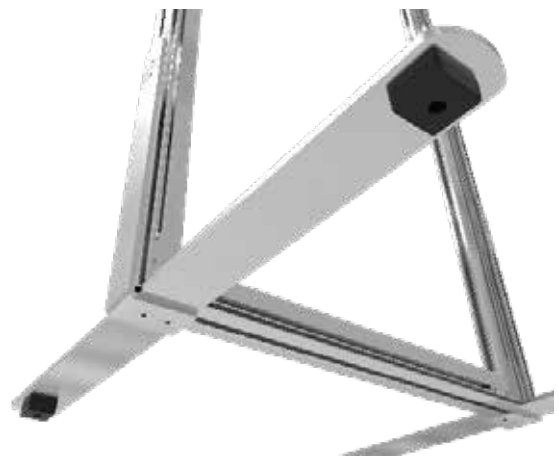

STANDING KIT / STÅENDE KIT	PROFILE / PROFILER	FEET / FÖTTER			CONNECTORS / CONNECTORS	
		TEXFOOT40	TEXFOOT60	TEXFEETSIDE	TEXMOUNT1	TEXMOUNT2
TEXKIT40-1	TEXDSD44 / TEXLEDDS-EL	V			V	
TEXKIT40-1S	TEXDSD44 / TEXLEDDS-EL	V		V	V	
TEXKIT60-1	TEXDSD44 / TEXLEDDS-EL		V		V	
TEXKIT60-1S	TEXDSD44 / TEXLEDDS-EL		V	V	V	
TEXKIT40-2	TEXLED80T / TEXLED100T	V				V
TEXKIT40-2S	TEXLED80T / TEXLED100T	V		V		V
TEXKIT60-2	TEXLED80T / TEXLED100T		V			V
TEXKIT60-2S	TEXLED80T / TEXLED100T		V	V		V

Note:

v = Accessories and screws are included in the kit. / Other textile profiles without track can be used as a freestanding kit while using drill holes.

Notering:

v = Accessoarer och skruvar är inkluderade i kittet / Andra textilprofiler utan spår kan användas som fristående kit om man använder borrhål.

TENSION PROFILES



www.cosign.nu

The Cosign Tension System is one of the most popular solutions for the professional installation of banners, flexface and other printed textiles including mesh and canvas. A very simple and versatile product, it is easy to use and requires no special tools. It is the perfect solution for a wide range of graphics and display projects.:

- Indoor and Outdoor signage projects
- Lightboxes
- Building wraps

Cosign's system vid namn Tension är en av de mest populära lösningarna för professionell installation av banderoller, banners, vepor och andra printade textilier som t.ex. meshväv och canvasduk. Detta är en enkel och mångsidig produkt, som är lätt att använda och som inte kräver några speciella verktyg.

Tension systemet, i dess enkelhet, är en utmärkt lösning till en lång rad av olika display- och utsmyckningsprojekt:

- Lämplig till såväl inom- som utomhusapplikationer
- Går även att använda till ljuslådor
- eller när man vill klä in stora ytor så som hela husfasader.



PROFILES & ACCESSORIES / PROFILER & ACCESSOARER

TENSION PROFILES TENSION PROFILER

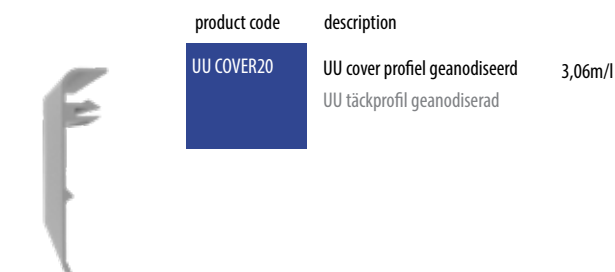
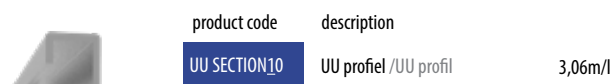
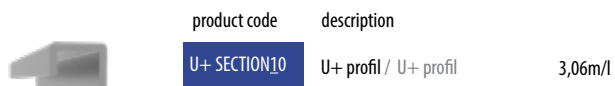
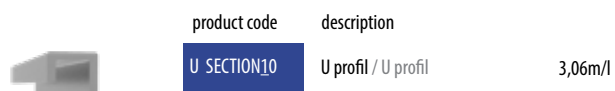

TENSION PROFILES TENSION PROFILER



ACCESSOIRES FOR TENSION PROFILES ACCESSOARER FÖR TENSION PROFILER

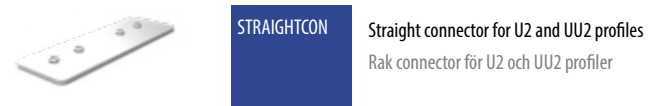
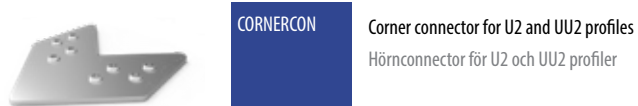

U PROFILE / U PROFIL



U+ PROFILE / U+ PROFIL



UU PROFILE / UU PROFIL



FIXINGS



www.cosign.nu

TIMELESS ELEGANCE

Over the last 10 years, Cosign has become the leading manufacturer of standoffs & sign fixings in the Benelux. Our designers chose to create fixings in an austere and modern design, in high-quality stainless steel (AISI 303 and 304).

Even though the sign fixings were designed for indoor use, many customers also use them outdoors in non-aggressive environments. Environments with chlorine, salt and metallic fumes must be avoided.

The design takes into account compatibility with sheets of glass. We use silicon rings to protect the sheets of glass or set screws with a nylon tip wherever possible.

Starting in 2015, all our standoffs & sign fixings spacers will also be available in stylish silver anodised aluminium and in a blister pack that will include the wall screws, plugs and allen keys.

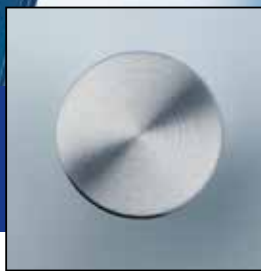

TIDLÖS ELEGANCE

Över de senaste 10 åren har Cosign blivit den ledande tillverkaren av skyltfästen i Belgien. Våra designers har tagit fram fästena och skylttillbehör i en enkel, stilsäker och modern design i rotfrött stål av hög kvalitet (AISI 303 and 304).

Även om fästena i första hand är tänkta att användas inomhus, så har många kunder även kunnat använda dem utomhus, men då i en icke utsatt miljö. Fästena bör inte monteras i miljöer med klor, salt och metalliska ångor.

Samtliga skyltfästen är utformade för att fungera väl med det skivmaterial som utgör skyltbudskapet oavsett vilken typ av skiva det rör sig om. Silikonringar och skruvar med nylonspets används på de mest utsatta ställena.

Från och med 2015 finns alla skyltfästen tillgängliga även i silveranodiserad aluminium. Ett snyggt och prisvärt alternativ. Alla förpackningar, oavsett material, inkluderar det man behöver till montering, så som skruv och plugg, samt insexnyckel.

SKYLTFÄSTEN & DISTANSER

KUPOLMUTTER

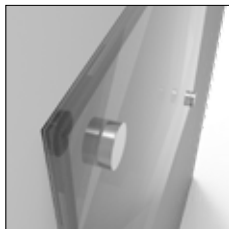

code inox kod inox	code aluminium kod aluminium	diameter (A) diameter
MB130000	MB130000-A	13mm
MB180000	MB180000-A	18mm

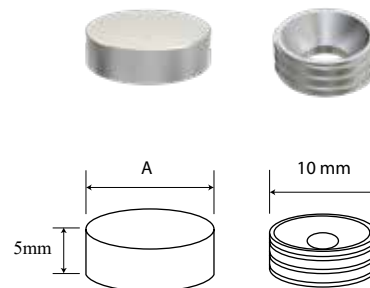
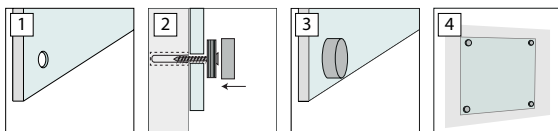

SKYLTFÄSTE FÖR GENOMGÅENDE HÅL



code inox kod inox	code aluminium kod aluminium	diameter (A) diameter	projection (B) distans	panel thickness skivtjocklek	diameter drillhole diameter borrhål
DH131507	DH131507-A	13mm	15mm	2-7mm	8mm
DH132012	DH132012-A	13mm	20mm	2-12mm	8mm
DH181507	DH181507-A	18mm	15mm	2-7mm	12mm
DH182512	DH182512-A	18mm	25mm	2-12mm	12mm
DH302512	DH302512-A	30mm	25mm	2-12mm	15mm

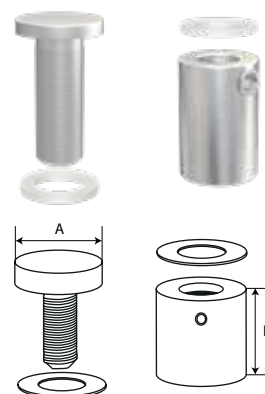
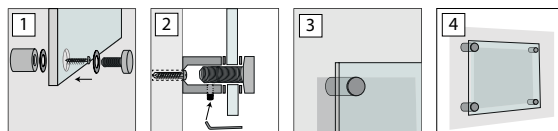

SKYLTFÄSTE SOM GREPPAR FRÅN SIDAN



code inox kod inox	code aluminium kod aluminium	diameter (A) diameter	projection (B) distans	panel thickness skivtjocklek
SG182008	SG182008-A	18mm	20mm	max 8mm
SG302008	SG302008-A	30mm	20mm	max 8mm

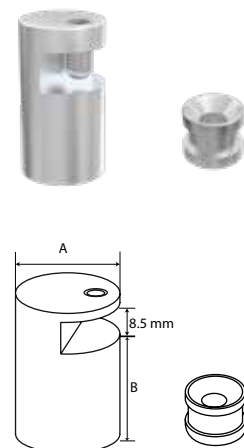
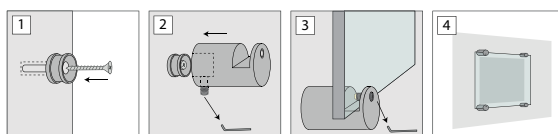

SKYLTFÄSTEN & DISTANSER

SKYLTFÄSTE FÖR UTSTICKANDE SKYLTT (VÄGG ELLER TAK)



code inox kod inox	code aluminium kod aluminium	diameter diameter	panel thickness skivtjocklek
WG170008	WG170008-A	17mm	max 8mm

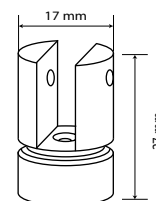
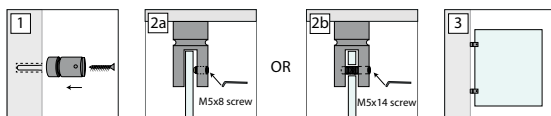

SKYLTFÄSTEN FÖR HÄNGANDE SKYLTT

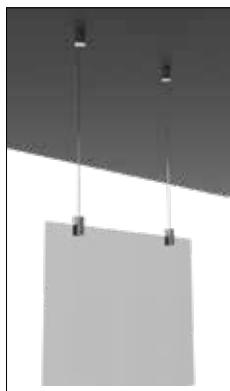

code inox kod inox	code aluminium kod aluminium	diameter diameter	panel thickness skivtjocklek	description beskrivning
CC15HP06	CC15HP06-A	17mm	max 6mm	suspension clamp enbart skyltfäste
CC15KIT4	CC15KIT4-A	17mm	max 6mm	suspension kit incl. ceilingconnector and wire. kit som inkluderar 1st skyltfäste, 1st enklare takfäste och 1st vajer.

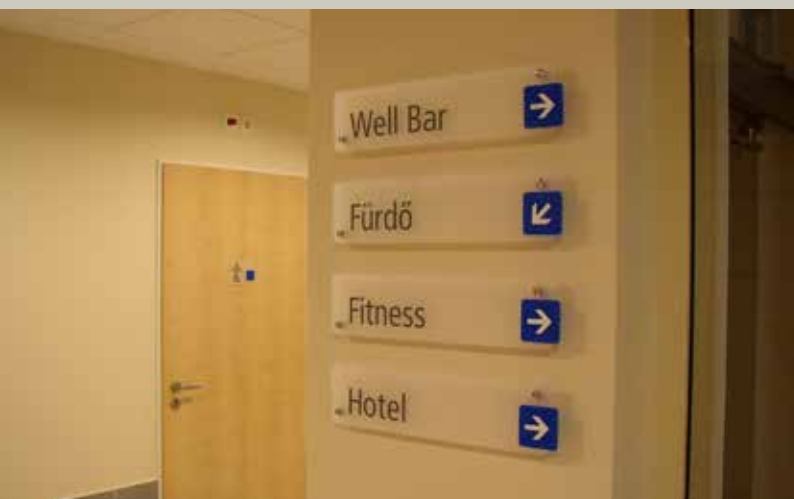
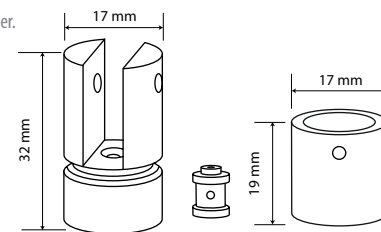
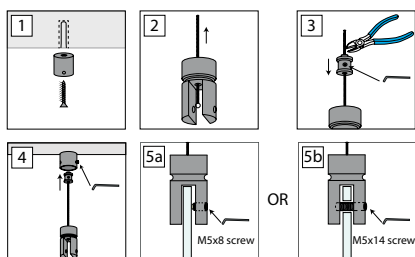

VAJERFÄSTEN





ENKELA ATT ANVÄNDA

Cosign har utvecklat en rad av vadersystem för hängande skyltar som garanterar en lätthanterlig, prisvärd och säker installation.

Alla varianterna av vajerfästen har en inbyggd låsmekanism som automatiskt greppar tag i vadjern. För att få vadjern att släppa, så finns det en knapp man trycker på. När vadjern är i friläge kan man justera så man får den höjd man vill ha.

I sortimentet finns vadersystem och skyltlösningar för alla typer av tak; allt från vanliga innertak med plattor, paneler och skenor, till tak med metallplattor eller betong, nedsänkta tak eller tak med mer öppen struktur och synliga bjälkar

HÄNGANDE SKYLTAR

TAKFÄSTEN



code

APC-4001

description
beskrivning

Suspension Clip Conical
Koniskt takfäste

cable thickness
vajertjocklek

max 1.5mm

max weight
max vikt

20,0kg

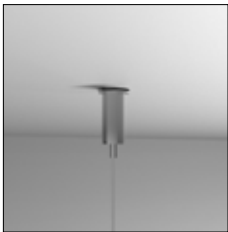

code

APC-4002

description
beskrivning

Suspension Clip Cylindrical
Cylindriskt takfäste

cable thickness
vajertjocklek

max 1.5mm

max weight
max vikt

20,0kg

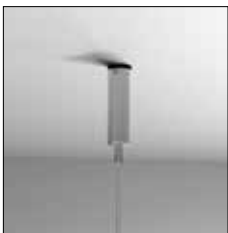

code

APC-4003

description
beskrivning

Suspension Clip Eco
Ecotakfäste

cable thickness
vajertjocklek

max 1.5mm

max weight
max vikt

20,0kg



VAJER

code

APC-CABLE-1.5

description
beskrivning

Galvanized cable (7x7). 1,5m length
with 4,5mm ball nipple.

Galvaniserad vajer (7x7). 1,5m lång med 4,5mm kulnippel

cable thickness
vajertjocklek

1.5mm

max weight
max vikt

16kg



NOTE:

Always consider maximum load of any used part of the total suspension system.

Håll koll på vilken maxvikt de individuella delarna i den upphängningsanordning du använder klarar.

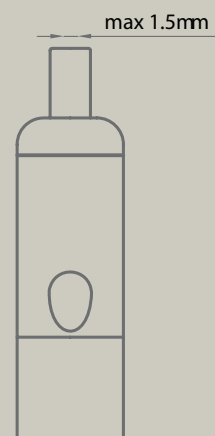
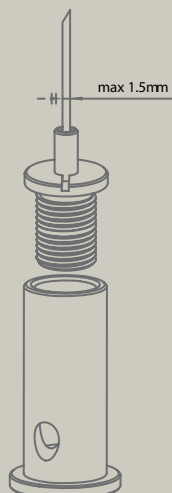
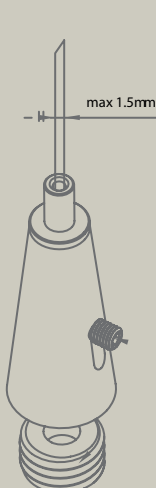

HÄNGANDE SKYLTA

MAGNET FÄSTE



code	description beskrivning	cable thickness vajer tjocklek	max weight max vikt
APC-MG32	Magnetic Anchor 32mm incl gripper Magnetfäste, 32mm inkl. vajerlåsning	max 1.5mm	2kg



VAJERFÄSTE

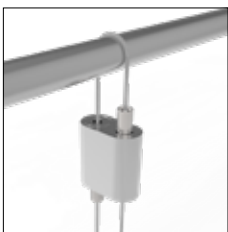

code	description beskrivning	cable thickness kabel tjocklek	max weight max vikt
APC-DG15-B	Double Gripper 1.5mm Black svart	max 1.5mm	20kg
APC-DG15-S	Double Gripper 1.5mm Silver silver	max 1.5mm	20kg
APC-DG30-B	Double Gripper 3.0mm Black svart	max 3,0mm	90kg
APC-DG30-S	Double Gripper 3.0mm Silver silver	max 3,0mm	90kg

Vajerfäste med dubbel genomföring/vajerlås



FÄSTE FÖR TAKSKENA



code	description beskrivning	cable thickness kabel tjocklek
APC-TW00	Twister Clip with 5,6mm loop med ögglå	-
APC-TW03	Twiser Clip with Gripper med vajerlås	max 1.5mm

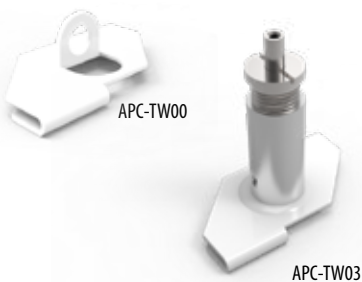

magnet strength: N35

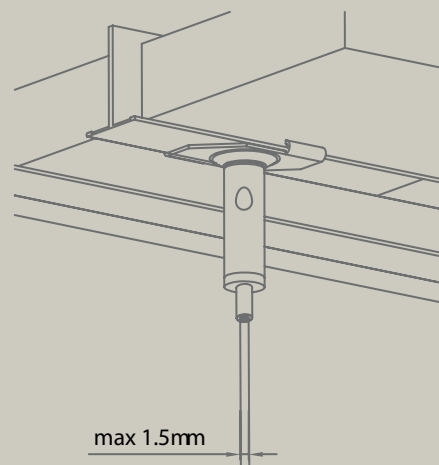
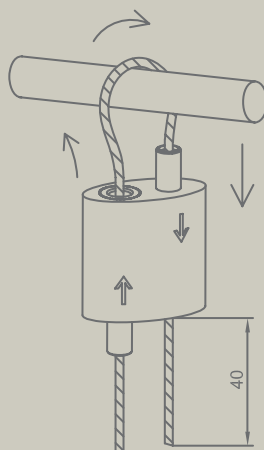
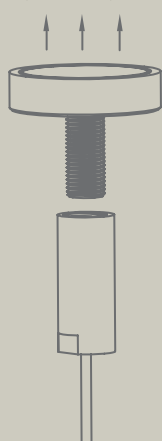

MODULE PLUS UTOMHUS



www.p3n.se

Cosign Module Plus Utomhus

STOLPSKYLTAR - Brett sortiment med allt du behöver för att plocka ihop en både snygg och unik stolpskylt.

Cosign Module Plus Utomhus är ett komplett skyltsystem av stolpskyltar för utomhusbruk.

Samtidigt som Module Plus har både modulära och utbytbara enheter, är skyltarna extremt robusta. Systemet består av flera olika typer av stolpar – runda, elliptiska, fyrkantiga mm – i kombination med ett brett utbud av lameller/paneler. Belysning finns som tillbehör.

Module Plus är en mångsidig och beprövad produkt för användning såväl utomhus som inomhus. Module Plus används i offentliga miljöer över hela världen och står emot både arktisk vinter och tropisk sommar.



PROFILÉS

STOLPAR

RUNDA STOLPAR

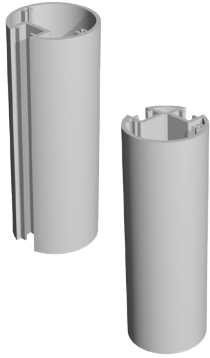

product code	description	
A00_1_60R1T	60mm round, 1-slot	6m/l
A00_1_60R2T	60mm round, 2-slots 60°	5m/l

1. mill finish brut 2. silver anodised anodisé naturel



product code	description	
A00_1_90R1T	90mm round, 1-slot	6m/l
A00_1_90R2T	90mm round, 2 slots 180°	5m/l

1. mill finish brut 2. silver anodised anodisé naturel

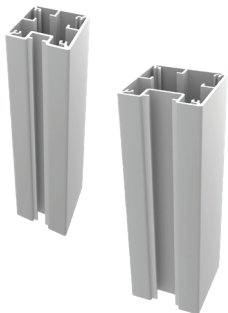

product code	description	
A00_1_60S1T	60mm square, 1-slot	6m/l
A00_1_80S1T	80mm square, 1-slot	6m/l

1. mill finish brut 2. silver anodised anodisé naturel

LOCK

RUNDA LOCK



product code	description	
AOTR601_1	60mm round, laser cut 2mm	60mm rond, coupé par laser 2mm

1. mill finish brut 2. silver anodised anodisé naturel



product code	description	
AOT600_1	60mm round, pp	60mm rond, pp

1. white/ blanc 2. grey/ gris 3. black/ noir



NEW

product code	description	
AOTR600_2	60mm round, die cast	60mm rond, moulé sous pression

2. grey powder coated laqué en gris 3. black powder coated laqué en noir



product code	description	
AOTR901_1	90mm round, laser cut 2mm	90mm rond, coupé par laser 2mm

1. mill finish brut 2. silver anodised anodisé naturel



NEW

product code	description	
AOTR900_2	90mm round, die cast	90mm rond, moulé sous pression

2. grey powder coated laqué en gris 3. black powder coated laqué en noir

FYRKANTIGA LOCK



NEW

product code	description	
AOTS601_1	60mm square, laser cut 2mm	60mm carré, coupé par laser 2mm

1. mill finish brut 2. silver anodised anodisé naturel



NEW

product code	description	
AOTS600_2	60mm square, die cast	60mm carré, moulé sous pression

2. grey powder coated laqué en gris 3. black powder coated laqué en noir



NEW

product code	description	
AOTS801_1	80mm square, laser cut 2mm	80mm carré, coupé par laser 2mm

1. mill finish brut 2. silver anodised anodisé naturel

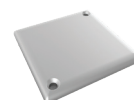

NEW

product code	description	
AOTS800_2	80mm square, die cast	80mm carré, moulé sous pression

2. grey powder coated laqué en gris 3. black powder coated laqué en noir

PROFILER

STOLPAR

NEW TRIANGEL STOLPAR



product code	description	
A00 1 60T1T	60mm triangular, 1-slot	6m/l
A00 1 90T1T	90mm triangular, 1-slot	6m/l
	1. mill finish brut	2. silver anodised anodisé naturel

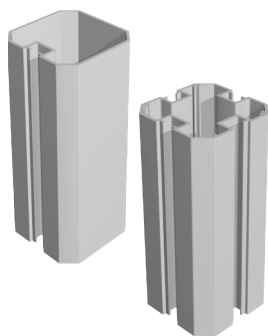

product code	description	
A00 1 8081T	80mm octagonal, 1-slot	5m/l
A00 1 8084T	80mm octagonal, 4-slots	5m/l
	1. mill finish brut	2. silver anodised anodisé naturel

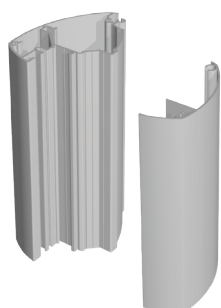

product code	description	
ELP 1 000	elliptical base profile	5m/l
ELP 1 001	elliptical hinge profile	5m/l
	1. mill finish brut	2. silver anodised anodisé naturel

LOCK



product code	description	
AOTT601 1	60mm triangular, laser cut 2mm	60mm triangulaire, coupé par laser 2mm
	1. mill finish brut	2. silver anodised anodisé naturel



product code	description	
AOTT600 2	60mm triangular, die cast	60mm triangulaire, moulé sous pression
	2. grey powder coated laqué en gris	3. black powder coated laqué en noir



product code	description	
AOTT901 1	90mm triangular, laser cut 2mm	90mm triangulaire, coupé par laser 2mm
	1. mill finish brut	2. silver anodised anodisé naturel



product code	description	
AOTT900 2	90mm triangular, die cast	90mm triangulaire, moulé sous pression
	2. grey powder coated laqué en gris	3. black powder coated laqué en noir



product code	description	
AOT8081	80mm octagonal, pp	80mm octogonaux, pp
	1. white/ blanc	2. grey/ gris
	3. black/ noir	



product code	description	
AOT8084	80mm octagonal, 4 slots, pe	80mm octogonaux, 4 slots, pe
	black acrylic / acrylic noir	



product code	description	
AOTE101 1	elliptical topcap, laser cut 2mm	capuchon elliptique, coupé par laser 2mm
	1. mill finish brut	2. silver anodised anodisé naturel

ACCESSOIRES

DOUBLE SIDED TEXTPANELS

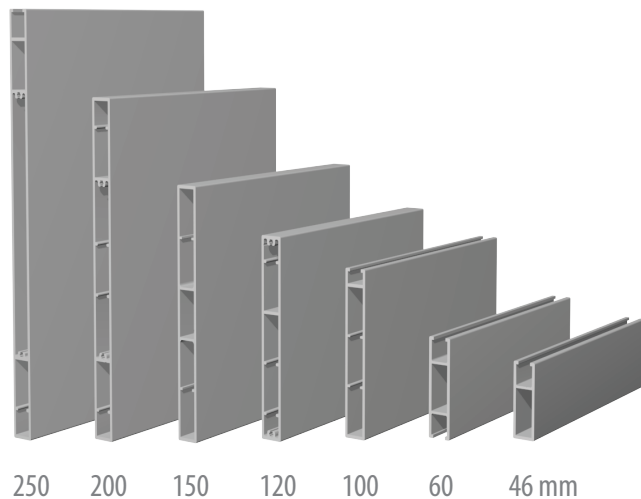

product code	description	
A00_1_250	250mm	5m/l
A00_1_200	200mm	5m/l
A00_1_150	150mm	5m/l
A00_1_120	120mm	5m/l
A00_1_100	100mm	5m/l
A00_1_060	60mm	5m/l
A00_1_046	46mm	5m/l

1. mill finish brut 2. silver anodised anodisé naturel

* Note : text panel open on top side : 250, 100, 46 mm
text panel open on both sides : 60 mm

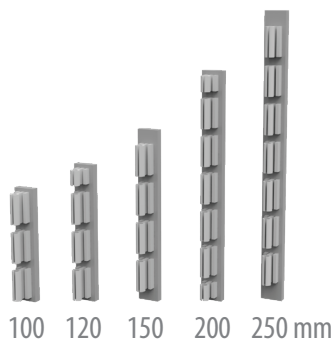

ALUMINIUM ENDCAPS



product code	description
AOC_1_250	250mm
AOC_1_200	200mm
AOC_1_150	150mm
AOC_1_120	120mm
AOC_1_100	100mm

1. mill finish brut 2. silver anodised anodisé naturel

PANEL CLAMP

	product code	description
	NEW AACL002	with inox screw / avec vis inox
	TOOL001	drilling guide for AACL002 / gabarit de perçage pour AACL002
	UPDATE FIXBOX001	without screw / sans vis



ACCESSORIES / ACCESSOIRES

STEEL FEET / PIEDS EN ACIER

product code	description
FEE1600	60mm round pole / poteau rond
DECOFEE2600	decorative foot / pied décoratif 60mm round pole / poteau rond
FEE19001T	90mm round pole / poteau rond
FEE19002T	90mm round pole / poteau rond, 2-slots
FEE18081T	80mm pole / poteau octogonal
FEE18084T	80mm pole / poteau octogonal, 4-slots
NEW FEE1605T	60mm square & triangular pole 60mm carré de triangulaire poteau
FEE1805T	80mm square & 90mm triangular pole 80mm carré de 90mm triangulaire poteau

FINISHING PROFILES / PROFILÉS DE FINITION

product code	description	
AOCO_1_00	finishing profile / profilé de finition	5m/l
	1. mill finish brut 2. silver anodised anodisé naturel	
ADAPTER_1_0	adapter profile / profilé de connection	5m/l
	1. mill finish brut 2. silver anodised anodisé naturel	
AORO_1_00	reduction profile / profilé de reduction	5m/l
	4mm plate material to be used instead of 8mm 1. mill finish brut 2. silver anodised anodisé naturel	
AOC_1_000	finishing profile of elliptical pole / profilé de finition	5m/l
	1. mill finish brut 2. silver anodised anodisé naturel	

ROUND CORNER CONNECTOR / ANGLE ARRONDI

product code	description
CORN_1_090	mill finish, for round pole 90mm brut, pour poteau rond 90mm

SCREW CAP / BOUCHON À VIS

product code	description
NOP002	screw cap / bouchon à vis
	1. white/ blanc 2. grey/ gris



INSTALLATION GUIDE / GUIDE D'INSTALLATION

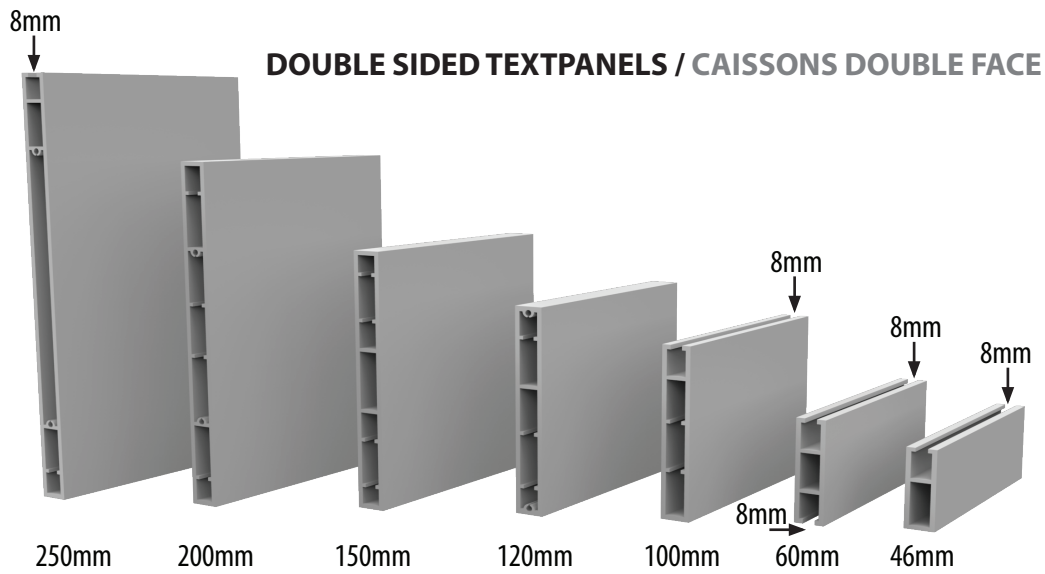

PANEL CLAMP / CRAMPON DE FIXATION

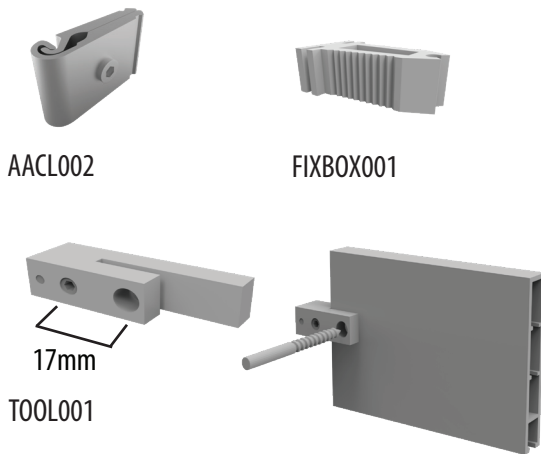

ALUMINIUM ENDCAPS PROFILÉS ALUMINIUM OBTURATEUR POUR CAISSONS

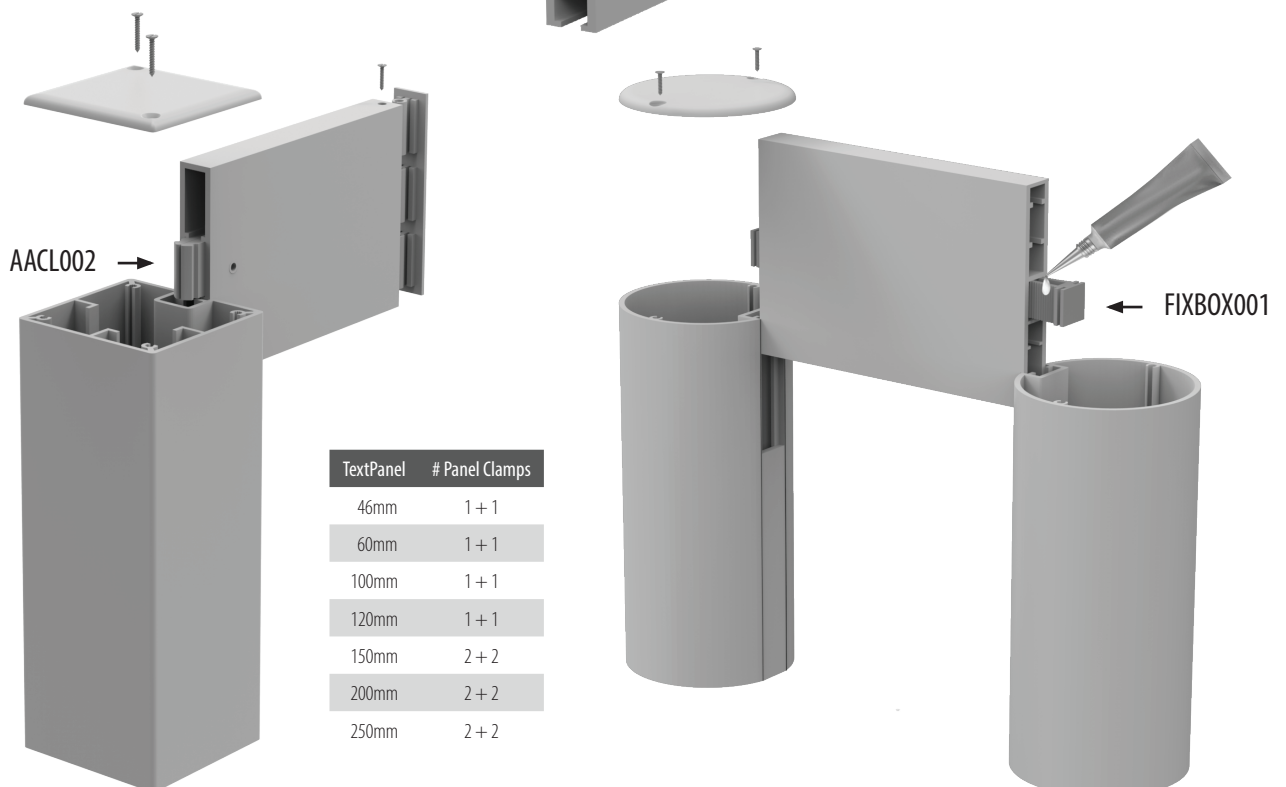
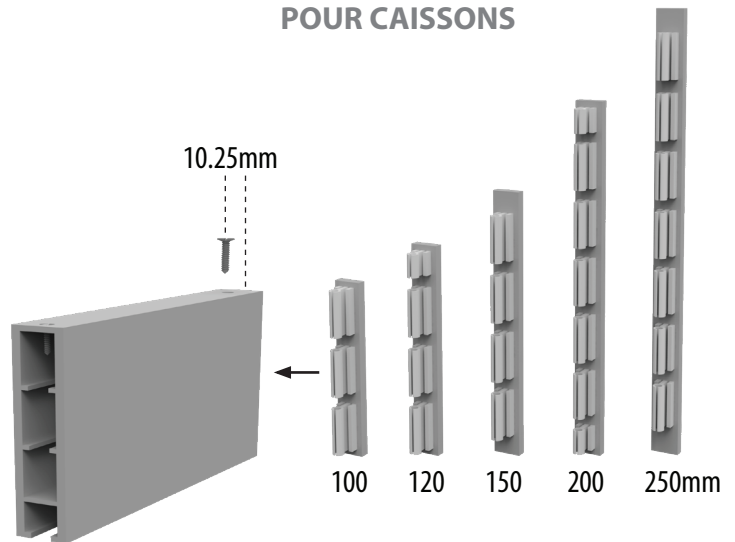

TextPanel	# Panel Clamps
46mm	1 + 1
60mm	1 + 1
100mm	1 + 1
120mm	1 + 1
150mm	2 + 2
200mm	2 + 2
250mm	2 + 2

INSTALLATION GUIDE / GUIDE D'INSTALLATION

FINISHING PROFILE / PROFILÉS DE FINITION

REDUCTION PROFILE / PROFILÉ DE REDUCTION

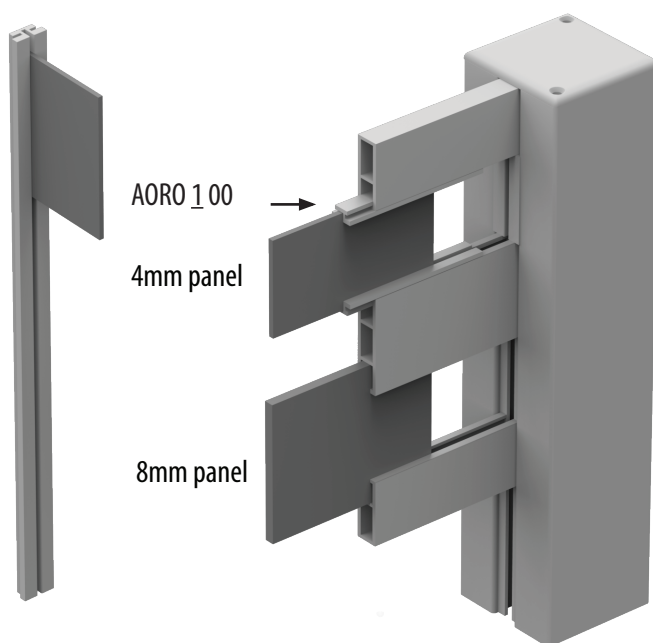

ADAPTER PROFILE PROFILÉ DE CONNEXION

OCTAGONAL POLE WITH TEXT PANELS POTEAU OCTOGONAL AVEC CAISSONS DOUBLE FACE

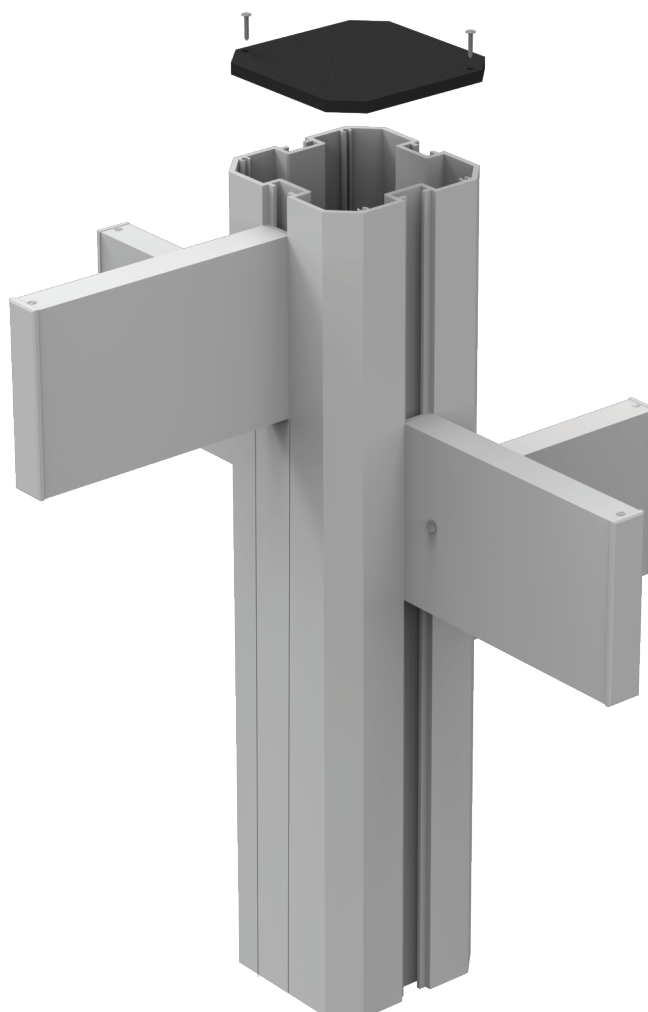
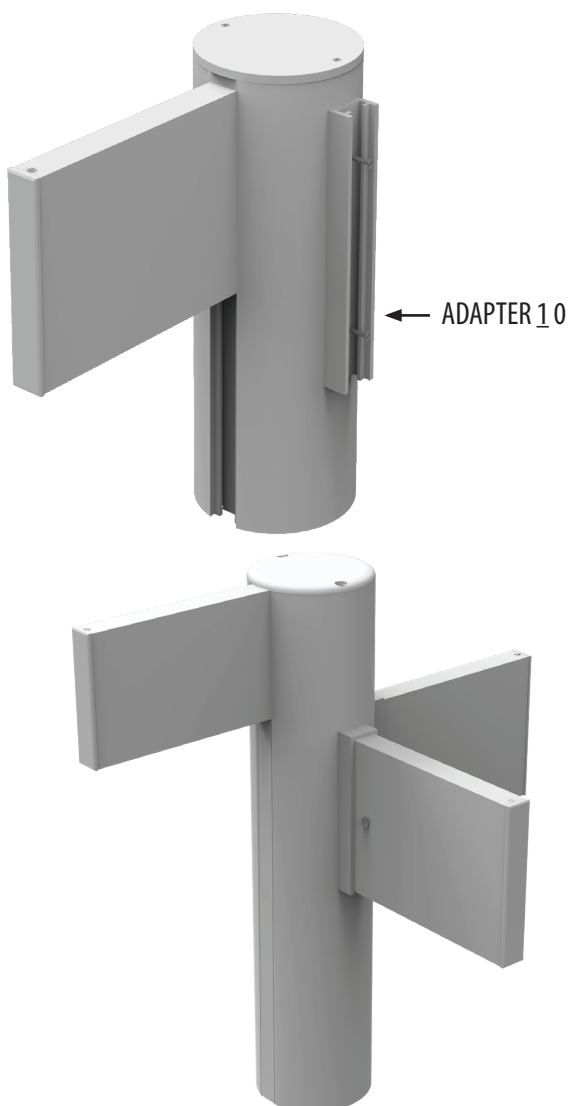

INSTALLATIONS GUIDE

ELLIPTICAL POLE ASSEMBLY



INSTALLATION GUIDE

RULES OF THUMB FOR SIGNS WITH MAXIMUM HEIGHT OF 2500MM OR MAXIMUM PANEL SURFACE OF 2M²

Concrete foundation:

1. Minimum diameter = 300mm
2. Depth (D) = 40% of the height of the structure (H) with a minimum of 300mm
3. The concrete should have at least 350 kg of cement per cubic meter

INSTALLING OPTIONS

1. POLES IN FOUNDATION

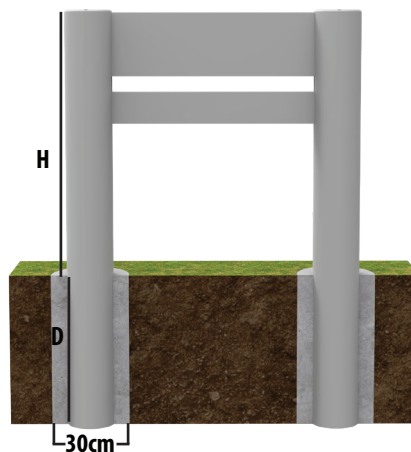

Example 1:
(H = 2m)

D = 40% x 2000mm
D = 800mm

Example 2:
(H = 50cm)

D = 40% x 500mm
D = 300mm
(MINIMUM REQUIREMENT)

2. INTERNAL STEEL STRUCTURE

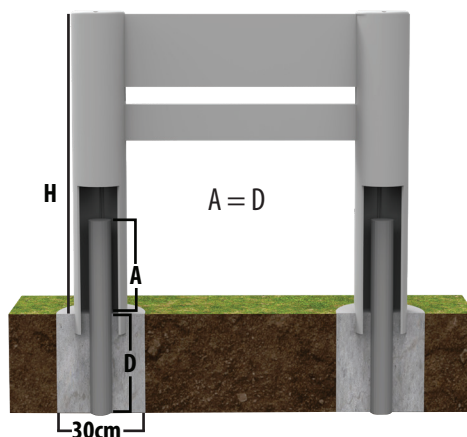

3. STEEL FEET / CHEMICAL ANCHORING

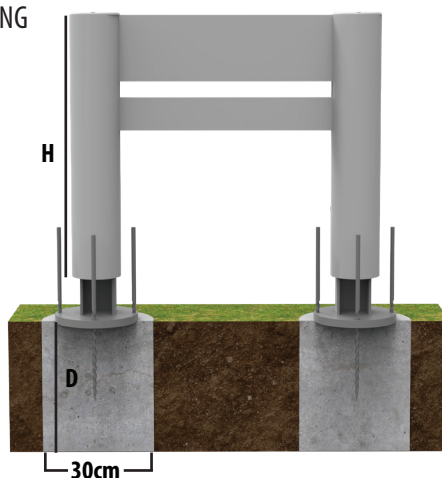

DISCLAIMER

The recommendations stated above are purely indicative. Since Cosign has no information regarding the specific location of the Module Plus Outdoor installation, the conditions of the soil and the composition of the concrete foundation, Cosign shall not be liable for any direct, indirect, incidental or consequential damages, arising out of or in any way connected with the use or misuse of our general advice.

For Module Plus Outdoor structures > 2,5m or a panel surface > 2m², please contact an engineering firm for strength/ stability calculations.

ANNONSPELARE
INFORMATIONS KYLTAR
ÖVERSIKTSSKYLTAR
HÄNVISNINGSSKYLTAR

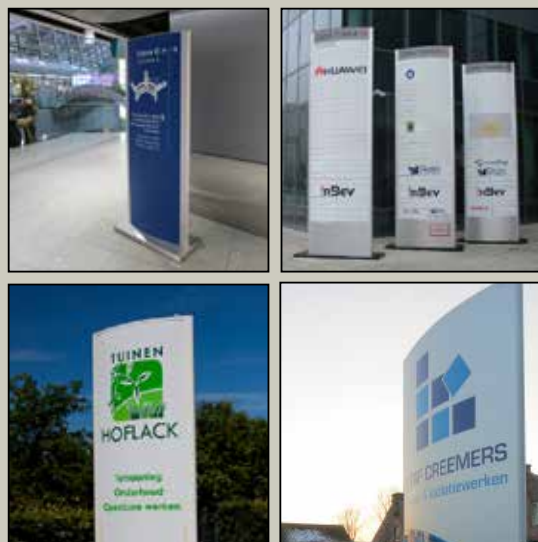

TOTEM PYLON

TOPPKLASS

Annonspelare finns överallt i dagens samhälle. En väl designad annonspelare synliggör din företagsverksamhet samtidigt som den bidrar till att stärka varumärket och den visuella identiteten.

När det gäller tillverkning av de aluminiumprofiler och de tillbehör som behövs för att bygga ihop denna typ av annonspelare, så är Cosign en stor aktör, speciellt i Belgien, där företaget först grundades.

Genom att välja en lämplig totemprofil som passar för ändamålet så kan man skapa såväl små, eleganta, golvstående inomhusskyltar, som stora, stabila utomhusskyltpelare upp till 6 meter höga. Till de större skyltarna är det oftast nödvändigt med en inre ram i aluminium eller stål.

Cosign levererar uteslutande till skyltmakare. Förutom profiler och tillbehör erbjuder de även en serie med "ready-made" annonspelare, antingen plana eller elliptiska i formen, i utmärkt kvalité.

TOTEM PYLON



De allra flesta är har någon gång stött på Cosign's klassiska Totem skyltprofiler. Dessa profiler utgör grunden i många av dagens reklampelare och kännetecknas av sin eleganta, svagt utbuktande, eller helt elliptiska form. Naturligtvis finns de i både belyst och icke belyst utförande.

Välj mellan ELLIPSE 50mm och ELLIPSE 80mm för mindre reklampelare (upp till 3m hög) eller ELLIPSE 137mm och nyttillskottet H-profilen för större pyloner (upp till 6m hög).

ALUMINIUM PROFILER

ELLIPSE 50mm ELLIPSE 50mm



product code profile / profil
TOT 1 050 50mm 6m/l

1. mill finish 2. silver anodised 3. color
 mill silver anodiserad färg



Double sided sign support 46mm (A001046)
 xDubbelsidigt stöd, 46mm(A001046)

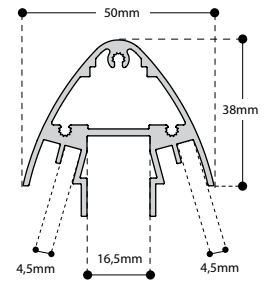

ELLIPSE 80mm ELLIPSE 80mm

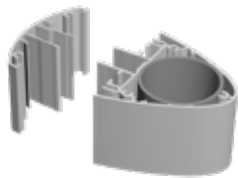

product code profile
TOT 1 080 80mm 6m/l

1. mill finish 2. silver anodised 3. color
 mill silver anodiserad färg

TOTCLOSE1080 afslutning / avslutning 6m/l

1. mill finish 2. silver anodised 3. color
 mill silver anodiserad färg



Round tube 50 x 4mm
 Rund tube 50 x 4mm

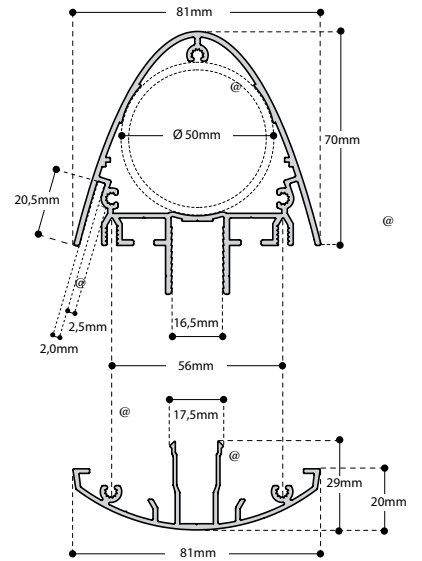

ELLIPSE 137mm ELLIPSE 137mm

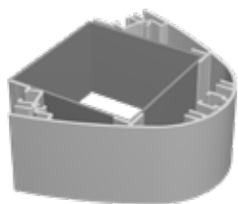

product code profile / profilé
TOT 1 137 137mm 6m/l

1. mill finish 2. silver anodised 3. color
 mill silver anodiserad färg



Aluminium or steel profile 80 x 80 x 4mm
 Aluminium- eller stålprofil 80 x 80 x 4mm

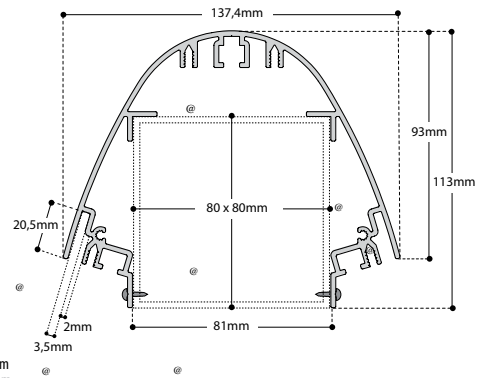

H-PROFILE PROFILE-H



product code profile / profilé
TOTH 1 060 H, 60mm 6m/l

1. mill finish 2. silver anodised 3. color
 mill silver anodiserad färg



Aluminium or steel profile 60 x 60 x 4mm
 Aluminium- eller stålprofil 60 x 60 x 4mm

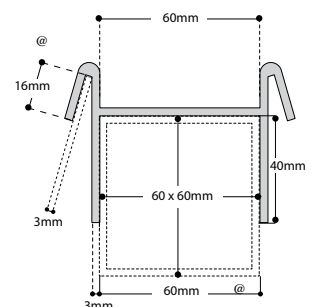

COSIGN

ARCHITECTURAL SIGNAGE



ARCHITECTURAL SIGNAGE | TEXTILE FRAMES | POS PRODUCTS | LED SOLUTIONS

Cosign är en utvecklare, tillverkare och distributör av arkitektonisk skyltning, vägvinnande skyltlösningar, textilramar, klicksystem med snäppramar och displaylösningar, LED-moduler och skyltmakartillbehör m.m. Huvudkontoret är baserat i Belgien med regionala kontor i Mexico, Brasilien och Indien. Tack vare vårt globala nätverk av återförsäljare är våra skyltlösningar och produkter tillgängliga i mer än 80 länder.

COSIGN